

# MIE ADR-1500

## Instruction Manual

Particulate Monitor

Part Number 108836-00

5Mar2010



© 2009 Thermo Fisher Scientific Inc. All rights reserved.

Specifications, terms and pricing are subject to change. Not all products are available in all countries. Please consult your local sales representative for details.

Thermo Fisher Scientific  
Air Quality Instruments  
27 Forge Parkway  
Franklin, MA 02038  
1-508-520-0430  
[www.thermo.com/aqi](http://www.thermo.com/aqi)

# WEEE Compliance

This product is required to comply with the European Union's Waste Electrical & Electronic Equipment (WEEE) Directive 2002/96/EC. It is marked with the following symbol:



Thermo Fisher Scientific has contracted with one or more recycling/disposal companies in each EU Member State, and this product should be disposed of or recycled through them. Further information on Thermo Fisher Scientific's compliance with these Directives, the recyclers in your country, and information on Thermo Fisher Scientific products which may assist the detection of substances subject to the RoHS Directive are available at: [www.thermo.com/WEEERoHS](http://www.thermo.com/WEEERoHS).



# About This Manual

This manual provides information about installing, operating, maintaining, and servicing the Model MIE ADR-1500 Particulate Monitor. It also contains important alerts to ensure safe operation and prevent equipment damage. The manual is organized into the following chapters and appendices to provide direct access to specific operation and service information.

Chapter 1 “[Introduction](#)” provides a general description of the instrument, and lists the specifications.

Chapter 2 “[Guidelines and Instrument Layout](#)” provides the guidelines and layout for instrument operation.

Chapter 3 “[Operation](#)” describes the operating modes, keypad functions, and menu-driven firmware.

Chapter 4 “[Calibration and Particle Size Selection](#)” provides the calibration process and procedures for calibrating the instrument.

Chapter 5 “[Maintenance and Service](#)” provides step-by-step instructions for repairing and replacing components, and a replacement parts list.

Chapter 6 “[Troubleshooting](#)” provides guidelines for diagnosing problems or failures, and includes recommended actions for restoring operation.

Chapter 7 “[Outputs and Alarm](#)” describes serial communications and analog/alarm output.

Chapter 8 “[Optional Accessories](#)” describes the optional equipment that can be used with this instrument.

Appendix A “[Warranty](#)” is a copy of the warranty statement.

Appendix B “[Serial Commands](#)” provides a list of the serial port commands that can be used to remotely control the instrument.





## Safety

Review the following safety information carefully before using the instrument. This manual provides specific information on how to operate the instrument, however, if the instrument is used in a manner not specified by the manufacturer, the protection provided by the equipment may be impaired.



# Safety and Equipment Damage Alerts

This manual contains important information to alert you to potential safety hazards and risks of equipment damage. Refer to the following types of alerts you may see in this manual.

## Safety and Equipment Damage Alert Descriptions

Alert	Description
 <b>DANGER</b>	A hazard is present that could result in death or serious personal injury if the warning is ignored. ▲
 <b>WARNING</b>	A hazard or an unsafe practice could result in serious personal injury if the warning is ignored. ▲
 <b>CAUTION</b>	A hazard or unsafe practice could result in minor to moderate personal injury if the warning is ignored. ▲
 <b>Equipment Damage</b>	A hazard or unsafe practice could result in property damage if the warning is ignored. ▲

## Safety and Equipment Damage Alerts in this Manual

Alert	Description
 <b>WARNING</b>	<p>The ADR-1500 must not be submersed. ▲</p> <p>The ADR-1500 must not exceed conditions greater than IP65. ▲</p> <p>The ADR-1500 should be operated only from the type of power sources described in this manual. ▲</p> <p>Shut off ADR-1500 before replacing the internal battery, or when plugging in or disconnecting the AC power supply. ▲</p> <p>Personal injury could occur when mounting the instrument. Assistance may be required. ▲</p> <p>The rechargeable lead acid battery must be charged in the up-right position. ▲</p> <p>Caution should be used when accessing or servicing any exposed wiring within the instrument. ▲</p> <p>Do not apply AC voltage to this connector. Maximum allowable DC voltage is 30 V. ▲</p>
 <b>CAUTION</b>	Disconnect battery power and external power supplies before servicing. ▲
 <b>Equipment Damage</b>	Do not attempt to lift the instrument by the cover or other external fittings. ▲

Alert	Description
	Whenever the ADR-1500 is shipped, care should be taken in repackaging it with the original factory provided packaging. ▲
	Damage could occur if not installed in a vertical, upright, position. ▲
	Damage may occur to the instrument if the environmental conditions exceed IP65. ▲
	Equipment damage may occur to instrument if power inputs or fuse type exceeds specified ranges. ▲
	Equipment damage may occur if exhaust port is blocked or port covers are not in place if unused. ▲
	Do not attach additional items to the handle for vertical hauling as this might compromise the strength of the handle and the ADR-1500 enclosure. ▲
	It should be noted that the ADR-1500 can be powered from any line with a voltage between 100-240 volts A.C., 50 to 60 Hz. No internal adjustments or selections need to be made for power lines with voltages and frequencies in those ranges. The internal AC-to-DC power unit performs any adjustments automatically. ▲
	Please note that the important purpose of the HEPA filter or filter cassette is to protect the pump. ▲
	At no time should the ADR-1500 be running without a filter in place, otherwise serious damage to the pump components may result. ▲
	Plugging or unplugging any external equipment (e.g., computer, modem, alarm circuitry, etc.) should be made only while both the ADR-1500 and the external equipment are shut off, in order to prevent damage or interference due to transient electrical effects. ▲
	It is recommended to turn the instrument and computer OFF before making a connection. ▲
	At no time should the ADR-1500 be running without a filter in place, otherwise serious damage to the internal components may result. ▲
	Unless a MALFUNCTION message is displayed, or other operational problems occur, the ADR-1500 should be returned to the factory once every year after being placed into service for routine check out, test, cleaning and calibration check. ▲
	Some internal components can be damaged by small amounts of static electricity. A properly grounded antistatic wrist strap must be worn while handling any internal component. ▲

Alert	Description
	<p>The instrument should be charged in the upright position. ▲</p> <p>Replace with specified battery only. ▲</p> <p>Disconnect the battery cable from the power communication board. ▲</p> <p>If unsuccessful, the instrument must be sent back to the factory for service. ▲</p> <p>For the 0 to 2 V output signal, the externally connected load must have an impedance of more than 200 kilo-ohms; For the 4 to 20 mA output signal, the externally connected load must have an impedance of less than 300 ohms. ▲</p>

## WEEE Symbol

The following symbol and description identify the WEEE marking used on the instrument and in the associated documentation.

Symbol	Description
	Marking of electrical and electronic equipment which applies to electrical and electronic equipment falling under the Directive 2002/96/EC (WEEE) and the equipment that has been put on the market after 13 August 2005. ▲

## Where to Get Help

Service is available from exclusive distributors worldwide. Contact one of the phone numbers below for product support and technical information or visit us on the web at [www.thermo.com/aqi](http://www.thermo.com/aqi).

1-866-282-0430 Toll Free

1-508-520-0430 International



# Contents

<b>Chapter 1</b>	<b>Introduction.....</b>	<b>1-1</b>
	General Description .....	1-3
	Specifications .....	1-7
<b>Chapter 2</b>	<b>Guidelines and Instrument Layout.....</b>	<b>2-1</b>
	Unpacking and Parts Identification .....	2-2
	Handling.....	2-3
	Safety .....	2-4
	Positioning.....	2-5
	Sampling Guidelines .....	2-9
	Instrument Layout .....	2-10
	Front Panel Display .....	2-11
	Bottom Power Port .....	2-12
	Side USB, Analog Panel .....	2-13
	Top View.....	2-14
	Rear View .....	2-15
	Preparation for Operation .....	2-16
	Power Options .....	2-16
	AC Power Connection .....	2-16
	Installing the Inlet.....	2-16
	Electrical Connections.....	2-17
	Environmental Constraints and Certifications.....	2-18
	Communications with Computer .....	2-19
	Software Installation Procedure.....	2-19
	Communication between ADR-1500 and Computer.....	2-19
<b>Chapter 3</b>	<b>Operation.....</b>	<b>3-1</b>
	Operating Modes .....	3-2
	Keypad and Screen Cursor Functions and Operation.....	3-3
	Key Press Functions .....	3-4
	Startup .....	3-5
	Operate Menu.....	3-6
	Start A Run.....	3-6
	Concentration/Scattering .....	3-6
	Elapsed Time .....	3-7
	Maximum Run Reading.....	3-7
	STEL .....	3-7
	Battery/Memory.....	3-8
	Temperature/RH .....	3-8

Flow/Pressure .....	3-8
Stop Run .....	3-9
Delayed Start .....	3-9
Delayed Start Edit .....	3-9
Start Time/Date .....	3-9
Start Time/Date Edit .....	3-10
Delayed Start Countdown .....	3-10
Zeroing the ADR-1500 .....	3-10
Zero In Progress .....	3-11
Zero Complete .....	3-11
Logging Parameters .....	3-11
Logging Status Edit .....	3-12
Logging Period Edit .....	3-12
Logging Site Edit .....	3-12
Logging Tag Number .....	3-13
Battery/Memory Status .....	3-13
Configure Menu .....	3-14
Display Average Time .....	3-14
Display Average Time Edit .....	3-14
Flow Rate .....	3-15
Flow Rate Edit .....	3-15
Logging Parameters .....	3-15
Logging Status Edit .....	3-16
Logging Period Edit .....	3-16
Logging Site Edit .....	3-16
Logging Tag Number .....	3-17
Inlet Type .....	3-17
Inlet Type Edit .....	3-17
RH Correction .....	3-18
RH Correction Edit .....	3-18
Alarm .....	3-18
Alarm Option Edit .....	3-19
Alarm Level Edit .....	3-19
Units .....	3-19
Units Edit .....	3-20
Analog Output .....	3-20
Analog Output Edit .....	3-20
LCD Backlight .....	3-21
LCD Backlight Edit .....	3-21
LCD Contrast .....	3-22
LCD Contrast Edit .....	3-22
Time/Date .....	3-22
Time/Date Edit .....	3-22
Calibrate Menu .....	3-24
Temperature Offset .....	3-24
Temperature Offset Edit .....	3-24

	Pressure Offset .....	3-25
	Pressure Offset Edit.....	3-25
	RH Offset .....	3-25
	RH Offset Edit .....	3-25
	Flow Rate Calibration .....	3-26
	Flow Rate Calibration Edit .....	3-26
	Calibration Factor .....	3-27
	Calibration Factor Edit .....	3-27
	Starting a Run .....	3-28
	Filter Requirements.....	3-28
	ZERO/Initialize Operation .....	3-28
	Auto-Start (Optional) .....	3-29
	Configuration Review .....	3-29
	Start the Run.....	3-32
<b>Chapter 4</b>	<b>Calibration and Particle Size Selection.....</b>	<b>4-1</b>
	Factory Calibration .....	4-2
	How to Apply a Correction Factor.....	4-3
	Site Calibration Factors.....	4-4
	Particle Size Cut Points .....	4-5
	Continuous Unattended Monitoring .....	4-6
<b>Chapter 5</b>	<b>Maintenance and Service.....</b>	<b>5-1</b>
	General Guidelines.....	5-2
	Replacement Parts List .....	5-3
	Instrument Storage.....	5-6
	Cleaning of Optical Sensing Chamber .....	5-7
	Removing the Internal Covers.....	5-8
	LCD Assembly Replacement.....	5-10
	Pump Assembly Replacement.....	5-12
	Communications PCB Replacement .....	5-14
	Optics Enclosure Assembly Removal.....	5-18
	Heater Switch Assembly Replacement.....	5-20
	Battery Use .....	5-23
	Lead Acid Battery Replacement.....	5-24
	In-Line Flow Meter Filter with Fittings Replacement.....	5-26
	Extended Monitoring HEPA Filter Replacement .....	5-27
	37-mm Filter Cassette Holder Assembly Replacement (Optional).....	5-28
	Bracket Assembly and Power Supply/Charger Replacement .....	5-30
	Service Locations.....	5-32
<b>Chapter 6</b>	<b>Troubleshooting .....</b>	<b>6-1</b>
	Safety Precautions .....	6-2
	Troubleshooting Guide.....	6-3
	Instrument Status Flags.....	6-5

	Board-Level Block Diagram .....	6-6
	Connector Pin Descriptions .....	6-7
	Service Locations.....	6-10
<b>Chapter 7</b>	<b>Outputs and Alarm.....</b>	<b>7-1</b>
	Analog Signal Output .....	7-2
	Alarm Description and Operation.....	7-3
	Analog Outputs.....	7-4
	Real-time RS-232 Output.....	7-6
	Serial Communications Protocols and Use of Modems .....	7-7
<b>Chapter 8</b>	<b>Optional Accessories.....</b>	<b>8-1</b>
	37-mm Filter Cassette Holder Assembly .....	8-2
	Relay Kit .....	8-3
	Alarm Relay Connection .....	8-3
	Inlets .....	8-5
	Cables .....	8-6
	Analog Data Cable.....	8-6
	12/24 VDC Cable.....	8-6
	Pole Mounting Kits.....	8-7
<b>Appendix A</b>	<b>Warranty.....</b>	<b>A-1</b>
<b>Appendix B</b>	<b>Serial Commands .....</b>	<b>B-1</b>

# Figures

<b>Figure 2–1.</b> ADR-1500 Pole Mount.....	2-6
<b>Figure 2–2.</b> ADR-1500 Horizontal Tab Wall Mount .....	2-7
<b>Figure 2–3.</b> ADR-1500 Vertical Tab Wall Mount .....	2-8
<b>Figure 2–4.</b> ADR-1500 Front View .....	2-10
<b>Figure 2–5.</b> ADR-1500 Front Panel LCD Display.....	2-11
<b>Figure 2–6.</b> ADR-1500 Bottom Power Port.....	2-12
<b>Figure 2–7.</b> ADR-1500 Side USB, Analog Panel.....	2-13
<b>Figure 2–8.</b> ADR-1500 Top View .....	2-14
<b>Figure 2–9.</b> ADR-1500 Rear View.....	2-15
<b>Figure 3–1.</b> Keypad Overview.....	3-3
<b>Figure 3–2.</b> Keypad Functions.....	3-4
<b>Figure 4–1.</b> Cyclone D50 Curves.....	4-5
<b>Figure 5–1.</b> ADR-1500 Instrument Layout .....	5-5
<b>Figure 5–2.</b> Removing the Internal Cover .....	5-9
<b>Figure 5–3.</b> Replacing the LCD Assembly .....	5-11
<b>Figure 5–4.</b> Replacing the Pump.....	5-13
<b>Figure 5–5.</b> Replacing the Communications PCB.....	5-15
<b>Figure 5–6.</b> Wiring Diagram 1 .....	5-16
<b>Figure 5–7.</b> Wiring Diagram 2 .....	5-17
<b>Figure 5–8.</b> Replacing the Heater Switch Assembly .....	5-21
<b>Figure 5–9.</b> Power/Com Assembly-Pump Installation .....	5-22
<b>Figure 5–10.</b> Replacing the Lead Acid Battery.....	5-25
<b>Figure 5–11.</b> Replacing the Filters.....	5-27
<b>Figure 5–12.</b> Replacing the 37-mm Filter Cassette Holder Assembly.....	5-28
<b>Figure 5–13.</b> Filter Support and Holder – Snap Rings and Filter .....	5-29
<b>Figure 5–14.</b> Replacing the Bracket Assembly and Power Supply/Charger....	5-31
<b>Figure 6–1.</b> ADR-1500 Board-Level Block Diagram .....	6-6
<b>Figure 7–1.</b> ADR-1500 External Analog Driver.....	7-4
<b>Figure 8–1.</b> Alarm Relay Connection.....	8-3
<b>Figure 8–2.</b> ADR-1500 Optional Accessories .....	8-8

## Figures

# Tables

<b>Table 1–1.</b> MIE ADR-1500 Specifications .....	1-7
<b>Table 5–1.</b> ADR-1500 Replacement Parts .....	5-3
<b>Table 6–1.</b> Troubleshooting – General Guide .....	6-3
<b>Table 6–2.</b> Troubleshooting – Error Code Responses from Zeroing .....	6-5
<b>Table 6–3.</b> ADR-1500 Communications Board Pin Out .....	6-7
<b>Table 7–1.</b> Analog Output Descriptions .....	7-4

## Tables



# Chapter 1

## Introduction

The Thermo Scientific Model ADR-1500 is a real-time particulate monitoring system designed for outdoor operation. The unit is designed for continuous unattended monitoring with continuous real-time data transmission to a central location and/or data logging. Its weatherproof enclosure ensures safe and effective operation under a wide range of ambient environmental conditions. Either a long-term monitoring HEPA filter or optional sample collection filter can be used. Options include sharp cut cyclones, tripod stand, relay and pole-mounting hardware.

The ADR-1500 incorporates light scattering photometry for which Thermo Fisher Scientific (formerly MIE) is known worldwide. Long-term, precise and drift-less measurements of airborne particulate matter concentrations down to  $1 \mu\text{g}/\text{m}^3$  are assured by a unique state-of-the-art combination of optical sensing and electronic processing techniques refined over the last 25 years.

The ADR-1500 can be used for size-selective particulate measurements using an omni-directional inlet and ACGIH traceable metal cyclones for monitoring  $\text{PM}_{10}$ ,  $\text{PM}_4$ ,  $\text{PM}_{2.5}$ , and  $\text{PM}_{1.0}$ . For suspended particulate monitoring the cyclone is removed from the inlet flow path and the inlet remains in place.

In addition to the real-time particulate measurements, the instrument provides the user with the capability to collect the sampled particles on a 37-millimeter filter for gravimetric and/or chemical analysis. Many NIOSH filters, and thereby NIOSH methods, are compatible with the ADR-1500.

A high-intensity flashing beacon is provided on the outside of the ADR-1500 for visual alarm whenever the measured particulate concentration exceeds a user selected alarm threshold. This alarm signal can be seen from a considerable distance and is intended principally for perimeter monitoring applications. For a description of the instrument and product specifications, see the following topics:

- “General Description” on page 1-3
- “Specifications” on page 1-7

## Introduction

Thermo Fisher Scientific is pleased to supply this ambient particulate monitoring system. We are committed to the manufacture of instruments exhibiting high standards of quality, performance, and workmanship. Service personnel are available for assistance with any questions or problems that may arise in the use of this monitor. For more information on Servicing, see Chapter 5, “[Maintenance and Service](#)”.

## General Description

The ADR-1500 is a complete particulate monitoring system designed to provide the user with continuous measurements of the concentration of airborne particles for suspended particulate and 50% cut-points ranging from  $PM_{10}$  down to  $PM_1$ , that is, the concentration of particles smaller than 10  $\mu m$  down to 1  $\mu m$  aerodynamic equivalent diameter, respectively.

Reference should be made to [Figure 5-1](#) of this manual for the location and identification of various component elements of the ADR-1500, described in this and subsequent sections of this manual.

The ADR-1500 samples the air through an omni-directional inlet, which ensures representative sampling of suspended particles, even under windy conditions. This inlet rises about 30 cm over the upper surface of the ADR-1500 enclosure. The sampled air stream can then enter an optional cyclone located downstream of the inlet, wherein particles larger than the cut-off diameter of the cyclone are retained, and those smaller than the cut-off diameter continue into the optical sensing stage of the monitor. The particle cut-off size is dependent on the sampling flow rate.

After the inlet assembly, the stream enters the optical sensing stage where the instantaneous concentration of airborne particulate matter is measured by light scattering photometry. It is important to point out that this sensing technique is independent of the speed with which the particles pass through the sensing stage, and therefore changes in flow rate have no effect on the measured concentration. However, changes in the flow rate will affect the particle cut-point if an optional cyclone is used.

After the particle mass concentration has been sensed photometrically, the stream passes through either a HEPA filter capsule (for long-term monitoring) or a standard 37-mm filter holder within which a membrane or fiber filter can be installed for further particle analysis (gravimetric, microscopic, chemical, etc.). When using the ADR-1500 for continuous unattended monitoring, however, it is advisable to use the HEPA capsule.

After passing through the filter stage, the filtered air stream then enters the flow assembly. This assembly contains a rotary vane pump and a volumetric flow rate control system based on sensing the pressure drop across a sub-sonic orifice that is protected by an inline filter. The sampling flow rate can be selected by keypad control on the front panel of the instrument.

After passing through the flow assembly, the air is exhausted from the ADR-1500 enclosure through a small bulkhead fitting. This exhaust port can also be used as a flow return in special sampling applications where the inlet of the ADR-1500 is connected to an environment at either positive or negative pressure (with respect to ambient).

The ADR-1500 accepts a universal A.C. power input (100-240 VAC, 50/60 Hz) or a 12-24 D.C. power input from an auxiliary power supply. The A.C. power is diverted to an internal 24 VDC power supply and a dedicated charger for the internal 12-Ah rechargeable lead acid battery. This battery is mounted at the base of the instrument and the 24 VDC power supply and battery charger are centrally mounted above the battery. Should the instrument be powered from an external auxiliary 12-24 VDC power source, a dedicated cable shall be used and it must be understood that the internal battery can not be charged from this auxiliary power supply.

The measured concentration of particulate matter is displayed in real time on the ADR-1500 LCD readout, provided digitally via USB and analog voltage and current signals updated every second. In addition, the user is provided with an alarm switching output to drive external devices (e.g., siren, shut-off equipment, etc.). The measured data can be logged internally in the ADR-1500 for subsequent downloading to a PC, modem, etc. The external USB port also serves to link to a PC for programming internal parameters of the ADR-1500 (e.g., logging period, measurement averaging time, alarm level, calibration constant, etc.). However, it should be noted that an additional RS-232 digital communications is reserved as in internal connection for most after-market wireless connections that may be made to the instrument.

The component elements of the ADR-1500 are designed to be CE certified, and the instrument is designed for IP65.

The ADR-1500 borrows the highly sensitive nephelometric (i.e., photometric) monitor from the pDR-1500 whose legacy light scattering sensing configuration has been optimized for the measurement of the respirable fraction of airborne dust, smoke, fumes and mists in industrial and other indoor and outdoor environments. The ADR-1500 incorporates a temperature and relative humidity (RH) sensor to mitigate the positive bias with elevated ambient RH. Additionally, the flow control is truly volumetric and is maintained through digital feedback of the onboard barometric pressure sensor, temperature sensor, and calibrated differential pressure across a precision orifice.

Downstream of the internal vacuum pump is a HEPA filter which will ensure a clean air source is delivered to the calibrated orifice and exhausted from the instrument. Zeroing is accomplished by attaching a HEPA filter to the inlet for a few minutes. By providing filtered air through the optical bench, the optical background of the instrument is established throughout the dynamic range of the instrument.

The ADR-1500 is a compact, rugged and totally self-contained instrument designed for rapid deployment and unattended operation mounted on a

wall, post, or tripod. It is powered either by its internal rechargeable battery, or by an AC supply or auxiliary power source.

The ADR-1500 covers a wide measurement range: from 0.001 mg/m<sup>3</sup> (1 µg/m<sup>3</sup>) to 400 mg/m<sup>3</sup>, a 400,000-fold span, corresponding to very clean air up to an extremely high aerosol concentration.

In addition to the auto-ranging real-time concentration readout, the ADR-1500 offers the user a wide range of information by scrolling its two-line LCD screen, such as run start time and date, time averaged concentration, elapsed run time, maximum and STEL values with times of occurrence, battery voltage, remaining data storage memory, temperature, RH, volumetric flow rate, barometric pressure, etc.

Operating parameters selected, diagnostic information, and calibration displays are also available with the ADR-1500. From the instrument display panel the user can:

- Enable a run
- Enable an auto-start run time and date
- Zero the instrument
- Fully configure data logging options
- Adjust display average time
- Adjust analog span output
- Identify type of inlet/cyclone installed
- Adjust flow rate with automatic D50 cut point feedback
- Enable/disable  $f(RH)$  correction
- Enable/disable the heater
- Enable/disable and select alarm output threshold
- Adjust time and date
- Enable/disable display backlight and contrast
- Calibrate barometric pressure, temperature, RH, flow rate, and dust response factor

Furthermore, the ADR-1500 features complete, large capacity internal data logging capabilities with retrieval through an externally connected computer via USB device. The stored information (> 450k data points) includes average concentration and maximum values with time information and tag numbers, operating parameters, error codes, and each time-stamped logged record provided concentration, temperature, RH, barometric pressure, and error status.

## Introduction

Selectable alarm levels with built-in audible signal and switched output, a USB communications port, and a programmable analog concentration output (voltage and current) are all part of this versatile instrument.

A custom software package (pDR Port) is provided with the ADR-1500 to program operating/logging parameters (e.g., logging period, alarm level, concentration display averaging time, etc.) as well as to download stored or real-time data to a PC or laptop for tabular and/or graphic presentation. If required, the data can also be imported to standard spreadsheet packages (e.g., Microsoft Excel™, Lotus 1-2-3™, etc.).

The ADR-1500 combines, easy to use menu-driven software, and advanced diagnostics to offer unsurpassed flexibility and reliability. The ADR-1500 specifications follow.

## Specifications

Table 1–1 lists the specifications for the Model ADR-1500.

**Table 1–1.** MIE ADR-1500 Specifications

Concentration measurement range (auto-ranging) <sup>1</sup>	0.001 to 400 mg/m <sup>3</sup>
Scattering coefficient range	$1.1 \times 10^{-6}$ to $0.6 \text{ m}^{-1}$ (approx.) @ $\lambda = 880 \text{ nm}$
Precision/repeatability over 30 days (2-sigma <sup>2</sup> with heater off and RH-correction disabled)	±2% of reading or ± 0.0015 mg/m <sup>3</sup> , whichever is larger, for 1-second averaging time ±0.5% of reading or ± 0.0015 mg/m <sup>3</sup> , whichever is larger, for 10-second averaging time ±0.2% of reading or ± 0.0005 mg/m <sup>3</sup> , whichever is larger, for 60-second averaging time
Accuracy <sup>1</sup>	±5% of reading (± precision) traceable to SAE Fine test dust
Resolution	0.1 µg/m <sup>3</sup>
Particle size range of maximum response	0.1 to 10 µm
Flow rate range	1.0 to 3.5 liters/min
Aerodynamic particle cut-point range	1.0 to 10 µm, with optional cyclone accessories
Concentration display updating interval	1 second
Concentration display averaging time <sup>3</sup>	1 to 60 seconds
Alarm level adjustment range <sup>3</sup>	Selectable over entire measurement range
Alarm averaging time <sup>3</sup>	Real-time (1 to 60 seconds), or STEL (15 minutes)
Data logging averaging periods <sup>3</sup>	1 second to 1 hour
Total number of data points that can be logged in memory	> 450,000
Number of data tags (data sets)	100 (0–99)
Logged data	Record no., concentration or scattering data, temperature, relative humidity, barometric pressure, data flags, time and date
Run summary	Model number, software version, serial no., tag number, start time, start date, logging period, cal factor, units of measure, RH correction setting, max. conc., time of max. conc., max. STEL, time of max. STEL, avg. conc., alarm on/off, alarm threshold, error codes, inlet setting, flow rate setting and site name

## Introduction

Elapsed time range	0 to 100 hours (resets to 0 after 100 hours)
Time keeping and data retention	> 10 years
Readout display	LCD 16 characters (4 mm height) x 2 lines
Serial interface	High Speed USB/RS-232 (RS-232 is reserved for wireless applications), 19,200 baud
Computer requirements	IBM-PC compatible, 486 or higher, Windows™ '95 or higher, ≥ 8 MB memory, > 10 MB hard disk drive, CD Drive, VGA or higher resolution monitor
Real-time digital signal (1 sec-1)	Concentration, flow, temperature, relative humidity, barometric pressure, time, date
Real-time analog signal <sup>1</sup>	0 to 2 V and 4 to 20 mA, with selectable full scale ranges between 0.1 and 400 mg/m <sup>3</sup> 0 - 0.1, 0 - 0.4, 0 - 1.0, 0 - 4.0, 0 - 10, 0 - 40, 0 - 100, and 0 - 400, mg/m <sup>3</sup> Minimum load impedance for voltage output: 200 kΩ Maximum load impedance for current output: 300 Ω (when powered by AC power supply)
Alarm output	Load impedance > 100 kΩ Alarm ON = short to ground Alarm OFF = open
Internal battery run time	1.2 L/min (heater and alarm off) > 100-hour run-time 1.2 L/min (heater and alarm constantly on > 24-hour run-time 3.5 L/min (heater and alarm constantly on > 12-hour run-time
Internal battery charge time <sup>4</sup>	95% charge capacity 7.3 hours (@100-250 VAC 50/60 Hz) 100% charge capacity 14 hours (@100-250 VAC 50/60 Hz)
AC source	100-240 VAC 50-60 Hz 12/24 VDC for solar or auxiliary battery options
Fuses	1.5 amp, slow blow fuse, 5 x 20 mm
Operating environment	-10 to 50 °C (14 to 122 °F), 10 to 95% RH, non-condensing
Storage environment:	-20 to 70 °C (-4 to 158 °F)
Dimensions)	21 in (533 mm) H x 17 in (431 mm) W x 17 in (215 mm D
Weight	28.5 lbs. (12.9 kg)
Optional Cyclones	GK 2.05 (Red) primarily for PM <sub>4</sub> thru PM <sub>10</sub> SCC 1.062 (Blue) primarily for PM <sub>1</sub> thru PM <sub>4</sub>



---

Integrated Sample Filter holder (Optional)	Millipore type MAWP 037 A0 (with 0.8 $\mu\text{m}$ pore size filter) Whatman type 1827 037 (with 1.5 $\mu\text{m}$ pore size filter) NIOSH Methods 0500 and 0600 use Millipore type PVC5 037 00 (with 5 $\mu\text{m}$ pore size filter) and a GK 2.05 Cyclone
Service Filter	Small integrated HEPA filter for flow meter protection Large integrated HEPA filter for long-term monitoring applications

---

## Notes:

<sup>1</sup> Referred to gravimetric calibration with SAE Fine (ISO Fine) test dust (mmd = 2 to 3  $\mu\text{m}$ ,  $g = 2.5$ , as aerosolized)

<sup>2</sup> At constant temperature and full battery voltage

<sup>3</sup> User selectable

<sup>4</sup> Internal battery will not charge when using 12-24 VDC external auxiliary power supply



## Chapter 2

# Guidelines and Instrument Layout

This chapter includes unpacking and parts identification, positioning and handling of the instrument, monitoring applications, instrument layout, outdoor provisions, and computer requirements.

- [“Unpacking and Parts Identification”](#) on page 2-2
- [“Handling”](#) on page 2-3
- [“Safety”](#) on page 2-4
- [“Positioning”](#) on page 2-5
- [“Sampling Guidelines”](#) on page 2-9
- [“Instrument Layout”](#) on page 2-10
- [“Preparation for Operation”](#) on page 2-16
- [“Environmental Constraints and Certifications”](#) on page 2-18
- [“Communications with Computer”](#) on page 2-19

## Unpacking and Parts Identification

Carefully unpack the ADR-1500 from the shipping container. The ADR-1500 is provided to the user with the following standard accessories:

- Power cord (110 or 220)
- Wall-mounting hardware
- USB communications cable
- pDR Port software CD ROM
- Particulate inlet
- Zeroing filter
- Instruction manual

If any parts are missing, contact Thermo Fisher Scientific immediately.



**Equipment Damage** Do not attempt to lift the instrument by the cover or other external fittings. ▲

**Note** Do not discard the packaging material. ▲

## Handling

The ADR-1500 is a sophisticated optical/electronic instrument and should be handled accordingly. Although the ADR-1500 is very rugged, it should not be subjected to excessive shock, vibration, temperature or humidity outside the stated specifications.



**WARNING** The ADR-1500 must not be submersed. ▲



**WARNING** The ADR-1500 must not exceed conditions greater than IP65. ▲

If the ADR-1500 has been exposed to low temperatures (e.g., in the trunk of a car during winter) for more than a few minutes, care should be taken to allow the instrument to return near room ambient temperature before operation. This is advisable because water vapor may condense on the interior surfaces of the ADR-1500 causing temporary malfunction or erroneous readings. Once the instrument warms up to temperature, such condensation will have evaporated. Re-zeroing is recommended upon installation.



**Equipment Damage** Whenever the ADR-1500 is shipped, care should be taken in repackaging it with the original factory provided packaging. ▲

## Safety

Review the following information carefully:

- Read and understand all instructions in this manual.
- Do not attempt to disassemble the instrument. If maintenance is required, return unit to the factory for qualified service or contact technical support.



**WARNING** The ADR-1500 should be operated only from the type of power sources described in this manual. ▲

- When installing or replacing the battery, follow the instructions provided within this manual.
- Shut off ADR-1500 and any external devices (e.g., PC) before connecting or disconnecting them.



**WARNING** Shut off ADR-1500 before replacing the internal battery, or when plugging in or disconnecting the AC power supply. ▲

## Positioning

The ADR-1500 real-time aerosol monitor can be operated in a vertical (upright) position and preferred for outdoor fixed location operation as well as for most indoor applications.

The ADR-1500 can be pole mounted (Figure 2-1) or wall (or post) mounted using the four wall mounting tabs that protrude above and below the enclosure. These tabs have mounting holes with a diameter of 5/16 (7.9 mm). If required, these mounting tabs can be removed. For details, see Figure 2-2 and Figure 2-3. For more information on the optional 2-inch, 3-inch, and 4-inch pole mounting kits, see chapter 8 “Optional Accessories”.

When mounting the ADR-1500 care should be taken to ensure that the front door of the unit can be opened without hindrance, and that free access is provided to the connectors and feed-throughs on the right face of the enclosure.

It is important to ensure free access of the air to be monitored to the sampling inlet. For ambient air monitoring, the omni-directional inlet provided with the ADR-1500 should always be used, and this inlet should not be obstructed by nearby objects, in order to ensure representative sampling.

Under typical operating conditions, the door of the ADR-1500 enclosure should be closed. Holes are provided on the enclosure to add a padlock to prevent unauthorized access to the interior of the unit. The door should be opened only to access the control keys of the ADR-1500, to replace either of the filters, or for other maintenance.



**WARNING** Personal injury could occur when mounting the instrument. Assistance may be required. ▲



**Equipment Damage** Damage could occur if not installed in a vertical, upright, position. ▲

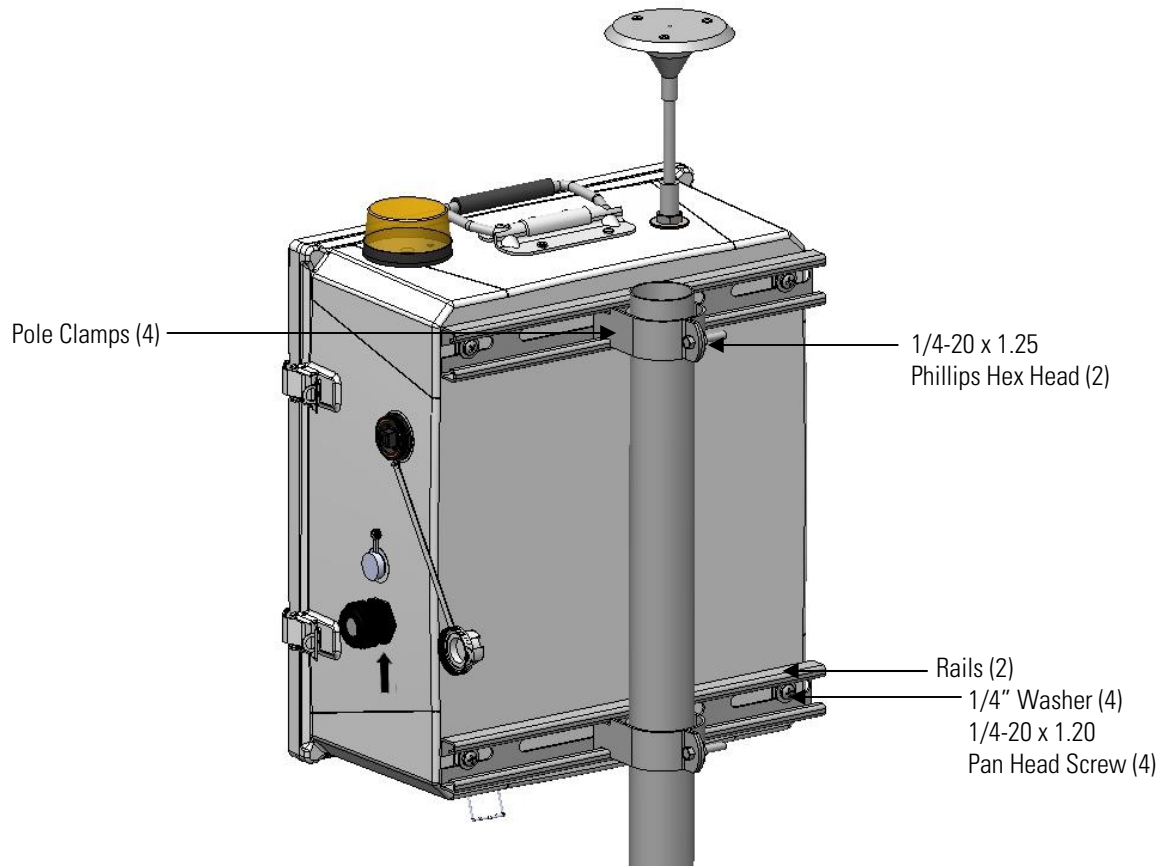
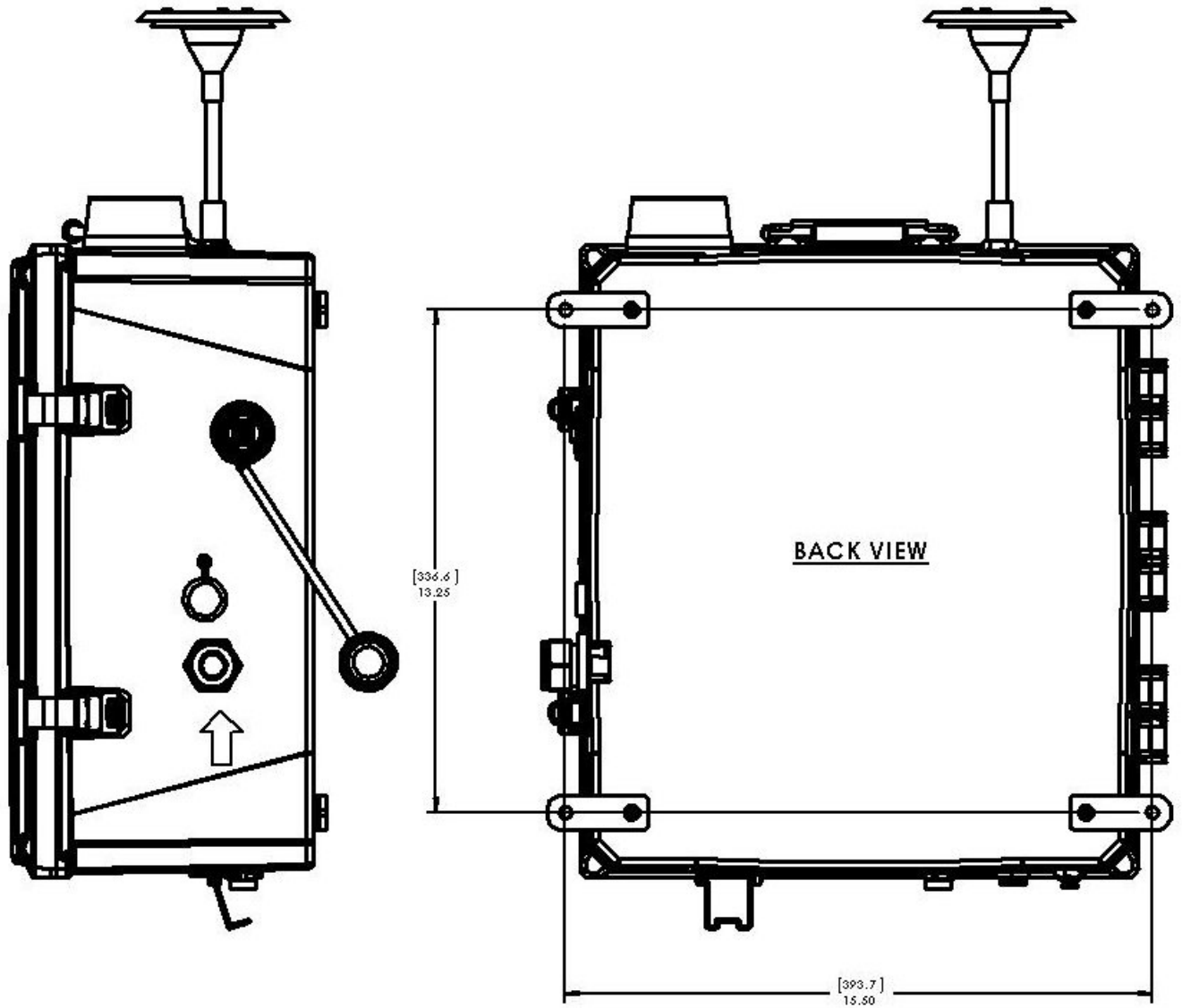

**Figure 2-1.** ADR-1500 Pole Mount



**WARNING** The rechargeable lead acid battery must be charged in the up-right position. ▲

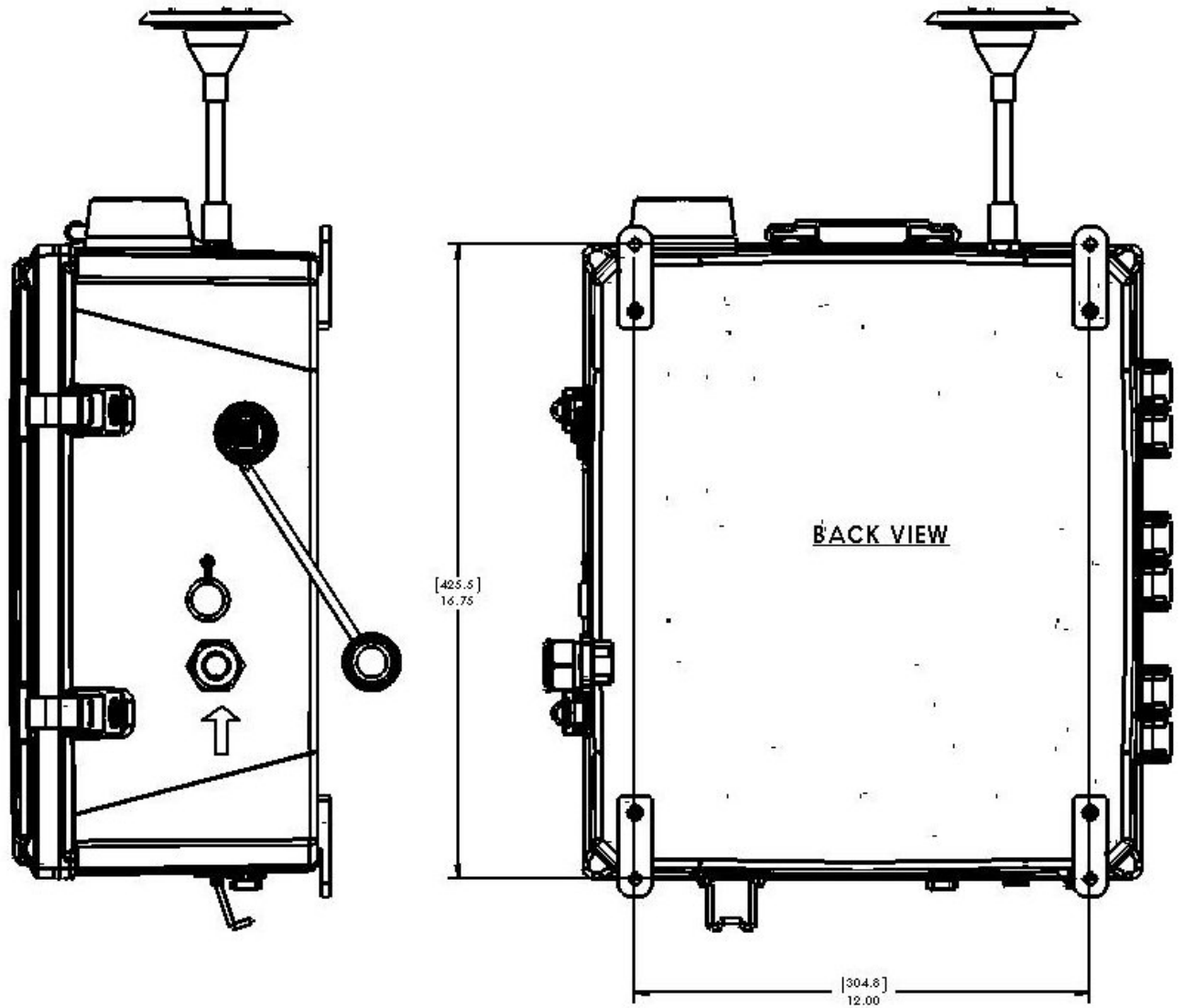



**Figure 2–2.** ADR-1500 Horizontal Tab Wall Mount



**WARNING** The rechargeable lead acid battery must be charged in the up-right position. ▲



**Figure 2-3.** ADR-1500 Vertical Tab Wall Mount



**WARNING** The rechargeable lead acid battery must be charged in the up-right position. ▲

## Sampling Guidelines

For ambient air sampling, the omni-directional inlet unit must be used to minimize wind speed and direction effects on particle sampling representativeness. This special omni-directional inlet is provided as a standard accessory of the ADR-1500. On receipt by the customer, this inlet will arrive packaged separately, and needs to be installed. Refer to [Figure 2–7](#) for the final (installed) appearance of the omni-directional inlet. To install proceed as follows:

Slide the omni-directional inlet onto the inlet stem of the ADR-1500 until it bottoms. To remove the omni-directional inlet, lift and twist the unit from the inlet stem.

If the ADR-1500 is to be used for extractive sampling (e.g., from a chamber, duct, stack, etc.) a flexible plastic tubing (preferably electrically conductive) can be used and connected to the inlet stem on the upper face of the ADR-1500. In this case the omni-directional inlet is not used and a 3/8-inch compression fitting with Teflon or nylon ferrules should be used.

For sampling situations involving water sprays, fog, etc. it is recommended that the in-line inlet heater be switched on. This optional operational configuration ensures the sample relative humidity will not exceed 70%. If not necessary, and to extend the run-time of the ADR-1500, when running off of the internal battery, simply switch the internal heater off.



**Equipment Damage** Damage may occur to the instrument if the environmental conditions exceed IP65. ▲

## Instrument Layout

The user should become familiar with the location and function of all externally accessible controls, connectors and other features of the ADR-1500. Refer to [Figure 2–4](#) and [Figure 5–1](#). All related functions are externally accessible.

Qualified Thermo Fisher Scientific personnel should perform all repair and maintenance. Please contact the factory if any problem should arise. Do not attempt to disassemble the ADR-1500, except as described in Chapter 5, “[Maintenance and Service](#)”, otherwise voiding of instrument warranty will result.



**WARNING** Caution should be used when accessing or servicing any exposed wiring within the instrument. ▲

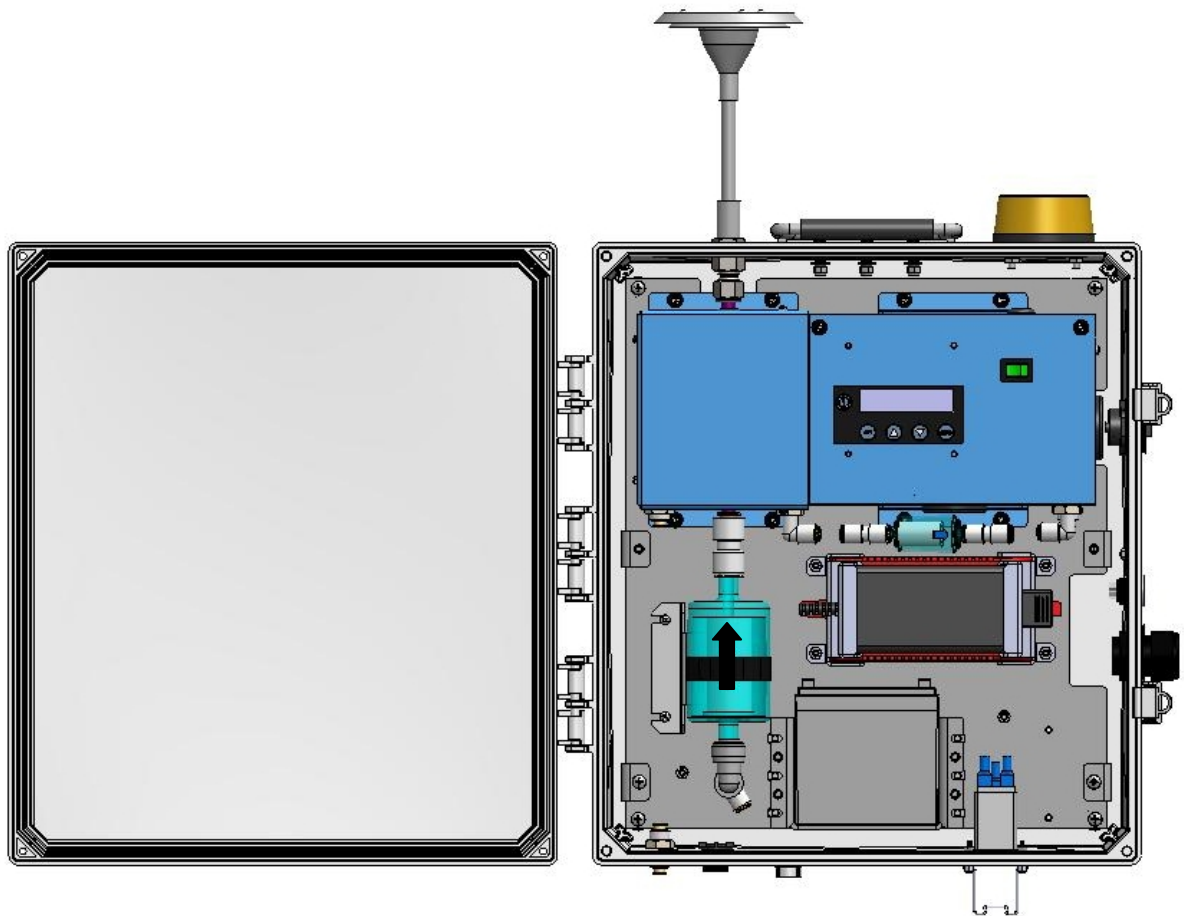

**Figure 2–4.** ADR-1500 Front View

## Front Panel Display

The front panel contains the five touch switches (keys) and the LCD screen required for the operation of the ADR-1500. The touch keys provide tactile ("popping") feedback when properly actuated. For more information on keys, see "Key Press Functions" on page 3-4

The two-line, 16-character per line LCD indicates either measured values of concentration (instantaneous and time averaged on the same screen), elapsed run time, maximum and short term excursion limit (STEL) values, operating and logging parameters, diagnostics, command prompting or other messages.

The LCD screen is backlit whenever the ADR-1500 is selected as an always on feature.

Refer to [Figure 2-5](#) for location of controls and display below.

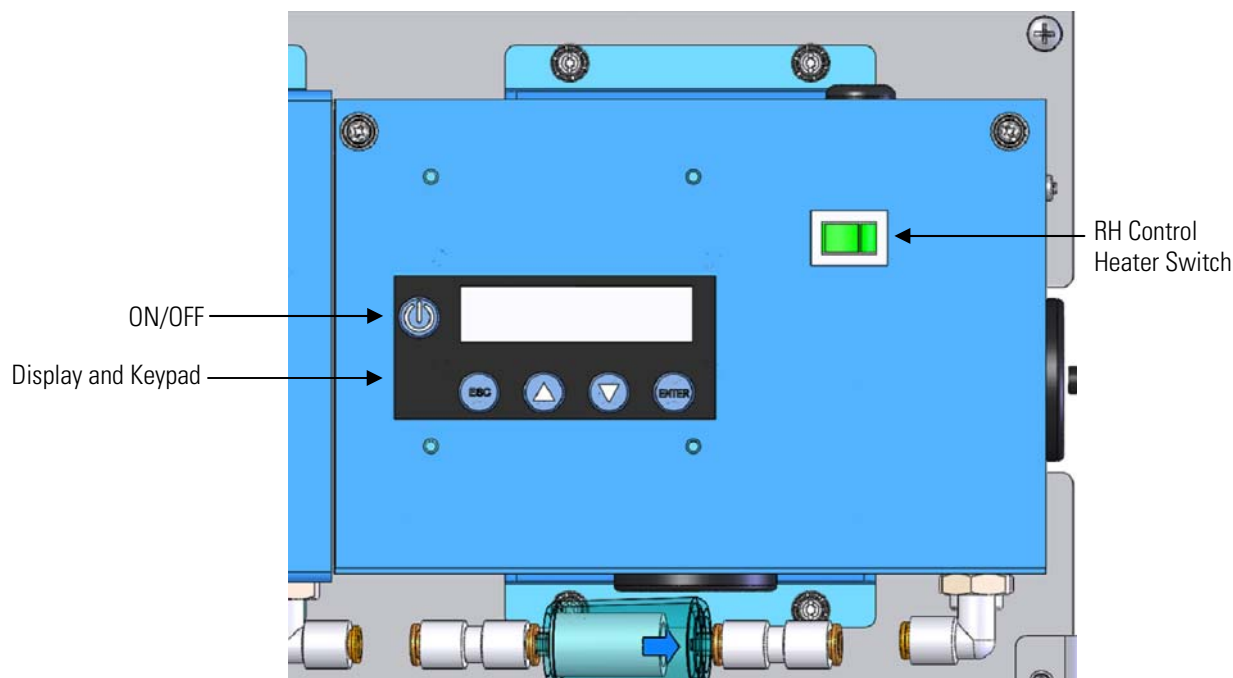

**Figure 2-5.** ADR-1500 Front Panel LCD Display

## Bottom Power Port

There are three critical components to the bottom panel of the ADR-1500; the universal AC power port (100-240 VAC 50/60 Hz), the auxiliary 12-24 VDC power port, and the instrument exhaust. The AC power should be connected whenever the internal batteries are exhausted or not present, and/or when running continuously from the AC line. Any other DC source (e.g., solar power supply, external battery, etc.) to be used to power the ADR-1500 would be connected to its respective port. Please note that the auxiliary 12-24 VDC will **not** charge the internal battery.

Refer to [Figure 2–6](#) below for the location of power port items on the bottom of the ADR-1500.



**Equipment Damage** Equipment damage may occur to instrument if power inputs or fuse type exceeds specified ranges. ▲



**Equipment Damage** Equipment damage may occur if exhaust port is blocked or port covers are not in place if unused. ▲

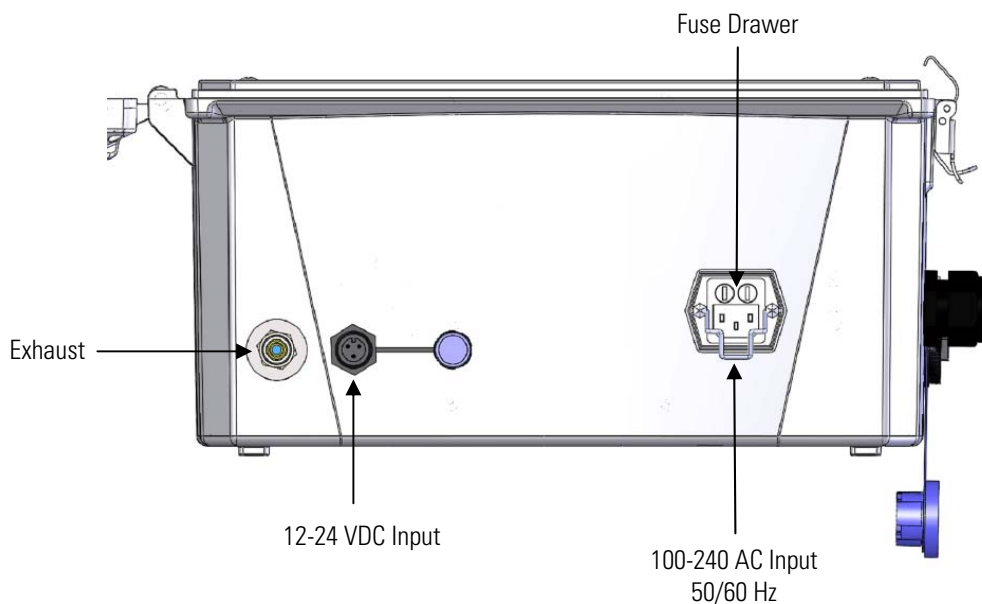

**Figure 2–6.** ADR-1500 Bottom Power Port

## Side USB, Analog Panel

There are four features of the right side of the ADR-1500 enclosure; the locking latches for the hinged door, the sealed USB connection, the sealed analog/alarm connect and a sealed cord grip. The locking latches join the enclosure body to the front door and compress the gasketing for proper sealing of the enclosure. These latches also permit the use of padlocks, if necessary. The sealed USB connector is used for PC-based communication for instrument configuration, data downloads and firmware upgrade using the factory-supplied pDR Port user interface. The sealed analog/alarm connector is for tying the ADR-1500 to an external data logger or PLC using the factory-supplied cable. The cord grip permits the user with access to the interior instrument for customization (e.g., wireless communications) and to the optional relay connector. For more information on options, see Chapter 8, “Optional Accessories”.

Refer to [Figure 2–7](#) below for the location of items on the Side USB, Analog Panel of the ADR-1500.



**Equipment Damage** Equipment damage may occur if exhaust port is blocked or port covers are not in place if unused. ▲

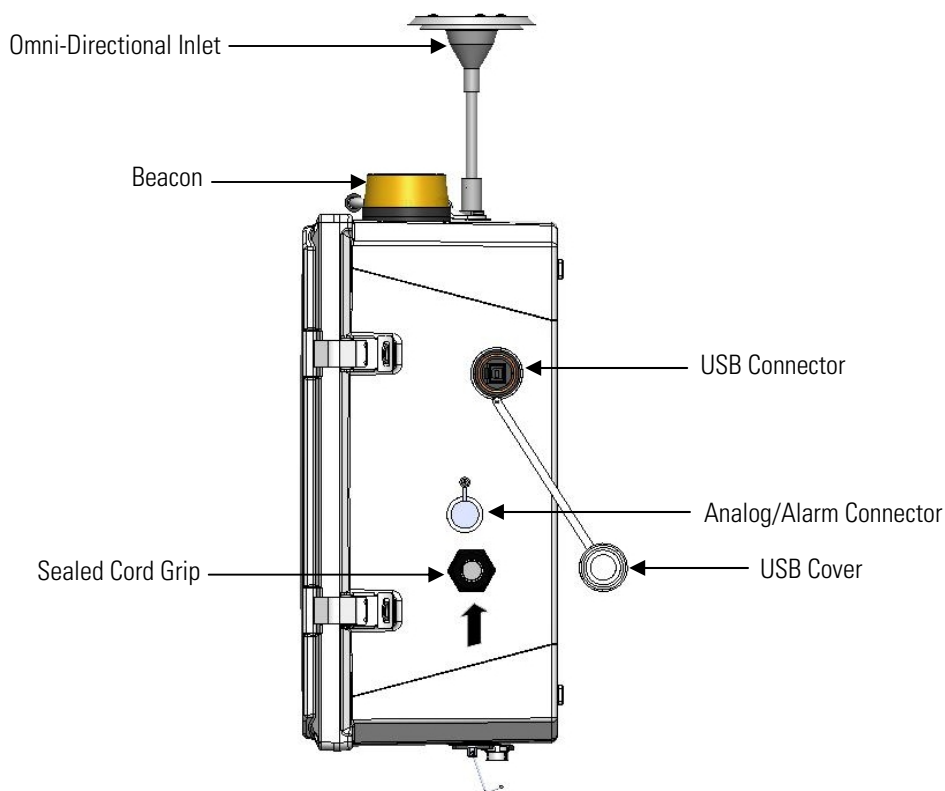

**Figure 2–7.** ADR-1500 Side USB, Analog Panel

## Top View

There are three features on the top of the ADR-1500; the inlet stem, the beacon, and the carry handle. The inlet stem is used to draw the sample into the nephelometric stage for aerosol sensing. This stem is 3/8-inch O.D. and is compatible with 3/8 compression fittings. It is recommended that the compression ferrules be made of nylon or Teflon; otherwise, compressed steel ferrules may render the instrument useless for backward compatibility with the intended inlet accessories. The connections to this stem are:

- Omni-directional inlet
- Cyclone adapter
- Zeroing filter
- 3/8-inch compression fitting with nylon or Teflon ferrules

The yellow beacon will flash if the alarm is enabled and the measured concentration exceeds the threshold chosen by the user. The alarm may be enabled for either an instantaneous value or for a STEL concentration.

The carry handle is to be used for carrying the instrument or hauling the instrument to an elevated installation. The carry handle is designed for the weight of the ADR-1500 only.



**Equipment Damage** Do not attach additional items to the handle for vertical hauling as this might compromise the strength of the handle and the ADR-1500 enclosure. ▲

Refer to [Figure 2–8](#) below for the location of items on the inlet stem, the beacon, and carry handle of the ADR-1500.

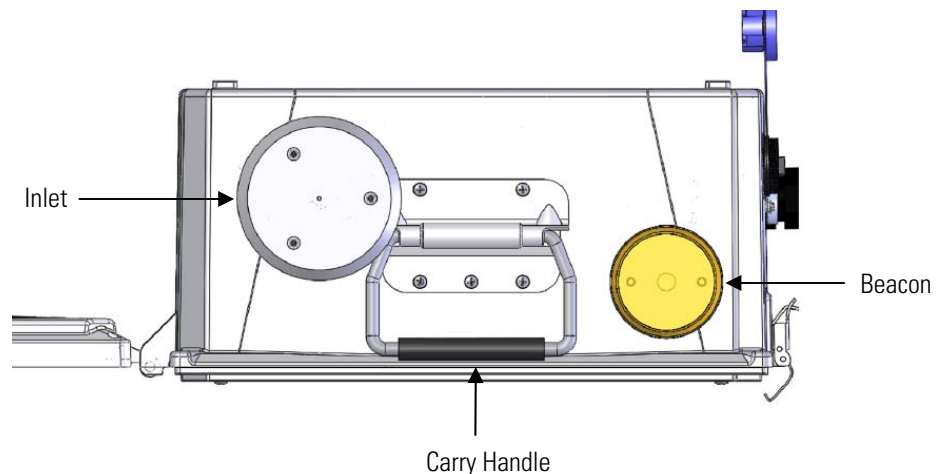

**Figure 2–8.** ADR-1500 Top View



## Rear View

The rear of the ADR-1500 shows four brass threaded bosses that can be used with the wall mounting kit (standard accessory). Furthermore, a pole-mounting kit (optional accessory) may be attached to the rear of the enclosure in a 2-inch, 3-inch, or 4-inch pole. Tripod mounting conversion kits are also available. For more information on mounting options, see Chapter 8, “Optional Accessories”.

Refer to [Figure 2-9](#) below for the location of the four brass threaded bosses.

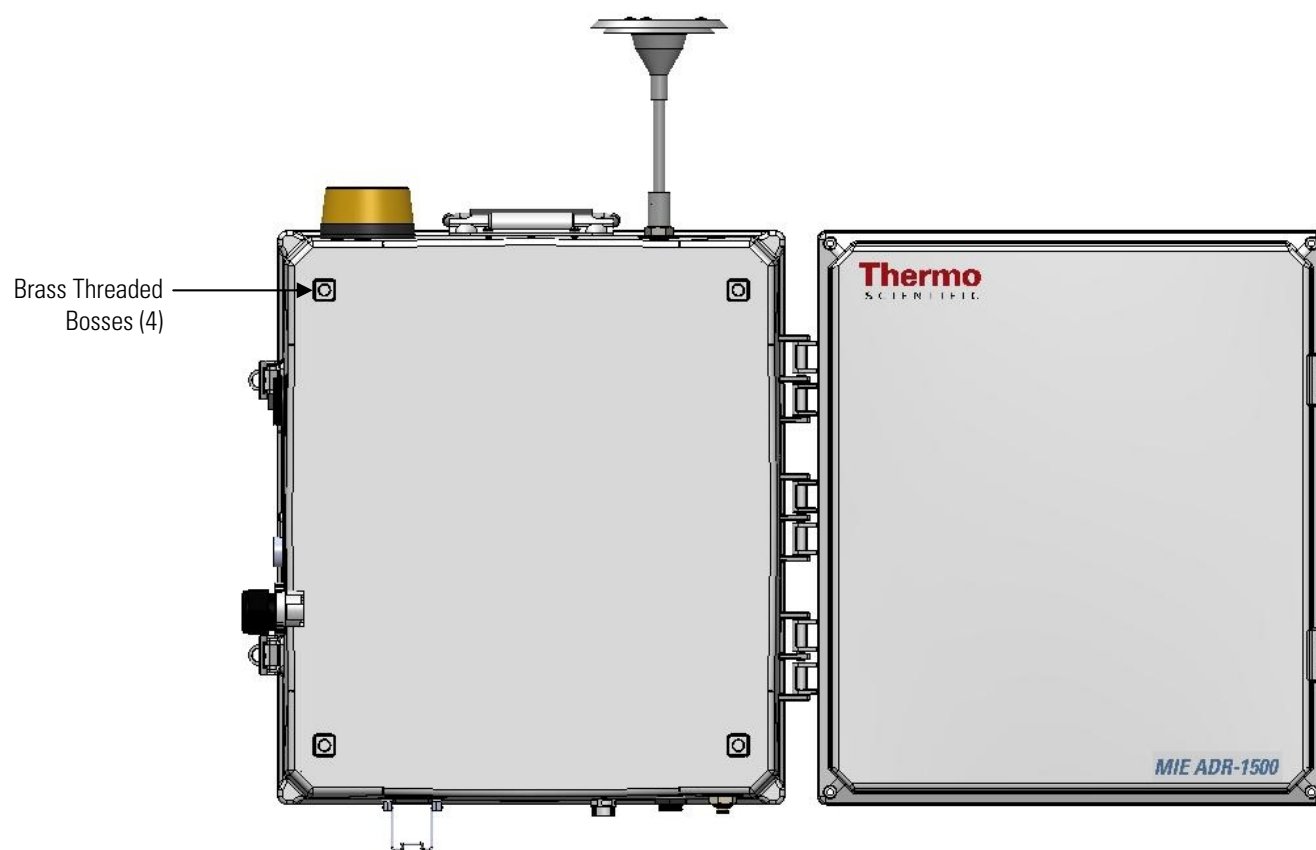

**Figure 2-9.** ADR-1500 Rear View

## Preparation for Operation

To begin using the ADR-1500, the user must first verify that either the AC/DC power supply is connected to both the instrument and suitable wall socket, or the instrument is installed with a charged battery.

### Power Options

The ADR-1500 has three basic power options:

- AC Power Supply (100-240 VAC 50/60 Hz)
- Auxiliary DC Power Supply (12-24 VDC)
- Battery Power (12 VDC 12 Ah lead acid)

An A.C. power cord (US or EU) is provided as a standard accessory with the ADR-1500 and is to be used with the universal A.C. power supply receptacle.

### AC Power Connection

The ADR-1500 as received from the factory is provided with an A.C. power cord and US or EU three-prong plug. The user can therefore connect the ADR-1500, as received, into an A.C. outlet to operate the system.



**Equipment Damage** It should be noted that the ADR-1500 can be powered from any line with a voltage between 100-240 volts A.C., 50 to 60 Hz. No internal adjustments or selections need to be made for power lines with voltages and frequencies in those ranges. The internal AC-to-DC power unit performs any adjustments automatically. ▲

### Installing the Inlet

Prior to starting a measurement run, it is recommended that the ADR-1500 is zeroed. This can be achieved by placing a HEPA filter onto the inlet stem and following the “[Zeroing the ADR-1500](#)” procedure on page 3-10. Do not attempt to zero through a cyclone.

The next step is to install a clean inlet assembly onto the inlet system. If a particle size cut-point is needed, an optional cyclone can be installed between the inlet stem and the omni-directional inlet.

If tubing is to be used, attach the tubing to the inlet stem or the cyclone stem.

The ADR-1500 is shipped from the factory with a high-capacity HEPA filter immediately downstream of the optical assembly. This permits periods of time. For sample recovery, it is recommended to use the optional 37-mm filter cassette holder, which can accommodate glass filter, Teflon, MCE and PVC filter material.



**Equipment Damage** Please note that the important purpose of the HEPA filter or filter cassette is to protect the pump. ▲



**Equipment Damage** At no time should the ADR-1500 be running without a filter in place, otherwise serious damage to the pump components may result. ▲

## Electrical Connections

If AC power is not available and the ADR-1500 must operate outside the instrument specifications for the internal battery, please consult with Thermo Fisher Scientific for a *Technical Note* regarding the use of an external battery or other DC source.



**Equipment Damage** Plugging or unplugging any external equipment (e.g., computer, modem, alarm circuitry, etc.) should be made only while both the ADR-1500 and the external equipment are shut off, in order to prevent damage or interference due to transient electrical effects. ▲

## **Environmental Constraints and Certifications**

The ADR-1500 is designed to be reasonably dust and splash resistant; it is weatherproof.

The pDR-1500 is certified for compliance with the electromagnetic radiation limits for a Class B digital device, pursuant to part 15 of the FCC Rules. The unit also complies and is marked with the CE (European Community) approval for both immunity to electromagnetic radiation and absence of excessive emission interference.

The unit also complies with:

- ANSI/UL 61010-1:2004, 2<sup>nd</sup> Edition, Safety Requirements for Electrical Equipment for Measurement, Control and Laboratory Use – Part 1: General Requirements
- CAN/CSA C22.2 No. 61010-1:2004 2<sup>nd</sup> Edition, Safety Requirements for Electrical Equipment for Measurement, Control and Laboratory Use – Part 1: General Requirements
- CENELEC EN 61326-1
- FCC 47 CFR 15B cIA

## Communications with Computer

The computer requirements to install and run the software provided with the ADR-1500 (pDR Port) is the following:

- IBM-PC compatible
- Pentium I or higher processor
- Minimum operating system: Windows 95 and later
- 32 MB of RAM
- 10 MB hard disk drive
- CD-ROM
- VGA or higher resolution monitor

Thermo Fisher Scientific custom hardware and software provided with ADR-1500 as standard accessories:

- USB communications cable
- Software CD (pDR Port)

### Software Installation Procedure

To install the Thermo Scientific provided software (pDR Port) in the computer, proceed as follows:

- Insert the CD labeled pDR Port into the computer
- The install program should start automatically
- The computer displayed install shield then serves to guide the rest of the installation.
- Please be sure to accept the Silicon Laboratories USB Driver installation.

### Communication between ADR-1500 and Computer



To effect the communication between the ADR-1500 (via the pDR Port software installed in the computer) and the PC, proceed as follows:

**Equipment Damage** It is recommended to turn the instrument and computer OFF before making a connection. ▲

- Connect the ADR-1500 to one of the computer's USB ports using the USB communication cable
- Key ON the ADR-1500; hold ON/OFF for **4 seconds**
- From your computer Start menu, or your computer desktop, open the pDR Port software program. A multi-tabbed notebook display should

appear on the computer screen. From the menu bar or the embedded Settings window, the serial connection port can be selected (e.g., COM 4). Select the port to which the USB cable has connected to on your computer using the Select Port pop-up window and click OK to proceed. The user may now click on the Show Instrument Panel to emulate the instrument keypad or utilize the tabs within the pDR Port notebook display.

Most operations with the pDR Port software program are self-evidently labeled, including fly-over dialog boxes. In addition, instructions may be found in the On-line Help files by selecting Help and then Contents.

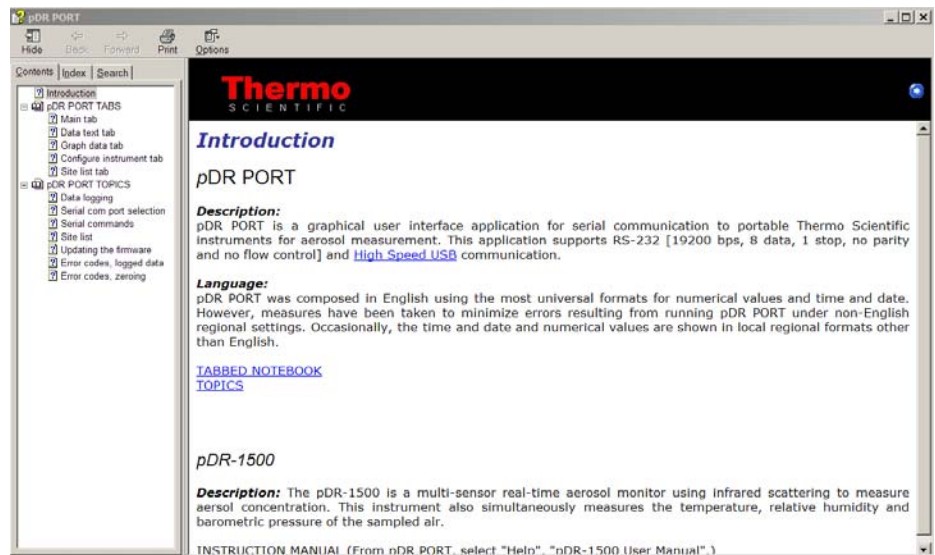



The following operating/logging parameters of the ADR-1500 can be selected (edited) via the computer:

- Current date (year, month and day of the month)
- Current time (hour, minute and second)
- Display averaging time (1 to 60 seconds, in 1-second increments)
- Calibration factor (0.01 to 9.99, in 0.01 increments)
- Analog output full scale concentration (0.1, 0.4, 1, 4, 10, 40, 100, or 400 mg/m<sup>3</sup>)
- Analog output status (enabled or disabled)
- Alarm level (0.001 to 400.0 mg/m<sup>3</sup>, in 1-μg/m<sup>3</sup> increments)
- Alarm status (enabled or disabled)
- Humidity correction (enabled or disabled)

The serial number of the ADR-1500 is transferred automatically to the PC and displayed on the screen. From the multi-tabbed notebook, select from the following options:

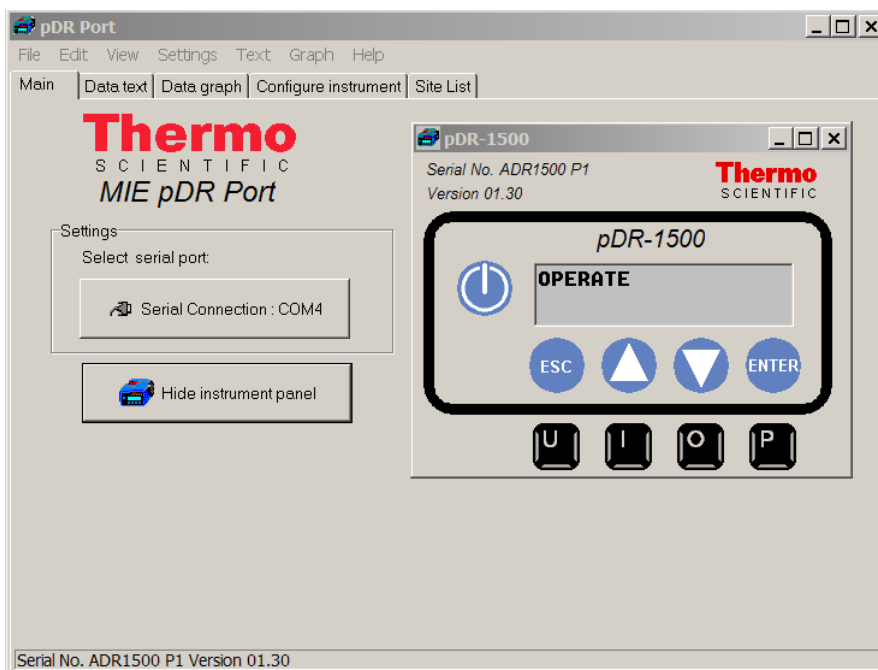
*Main.* This tab allows the user to select the serial port connection, and show or hide the instrument panel.



*Data text.* This tab allows the user to download, tabulate, print and delete data, or transfer to a CSV file of the data downloaded from the ADR-1500. First – click on the blue instrument icon (  ) in the upper left hand corner of this Data text Tab and the “Select a Tag number” window will appear. From this window, the user can select a single Tag (data file) to be loaded or deleted. In the image below, the “Delete all data” box appears with a check mark. By selecting this box and clicking on Delete, all tag files can be deleted at once.

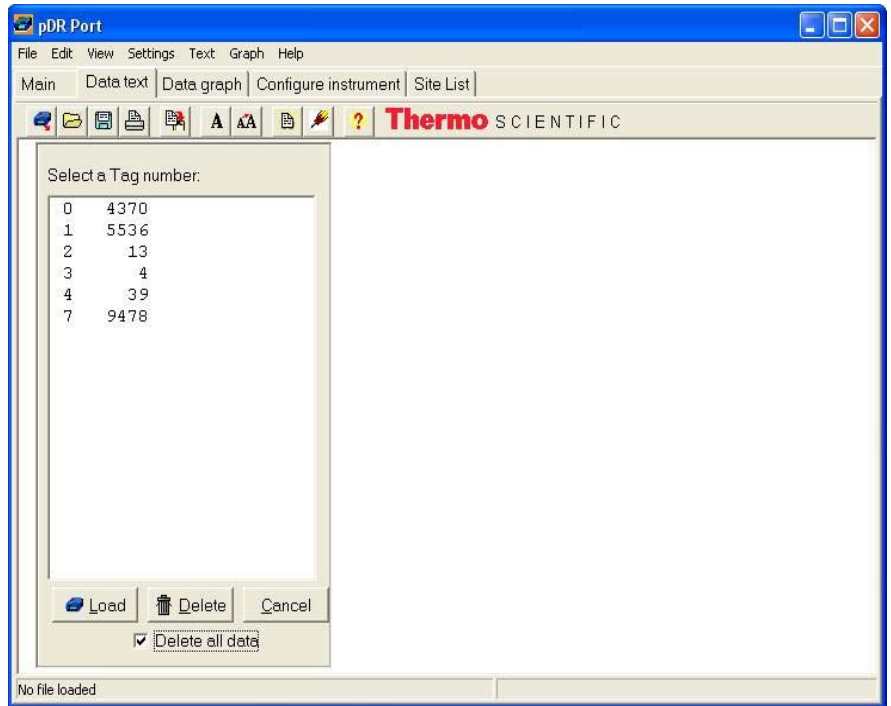

In this second image of the Data Text tab, it shows a Tag File loaded to the window. The data can now be viewed in the Data Graph tab and saved as a CSV file.

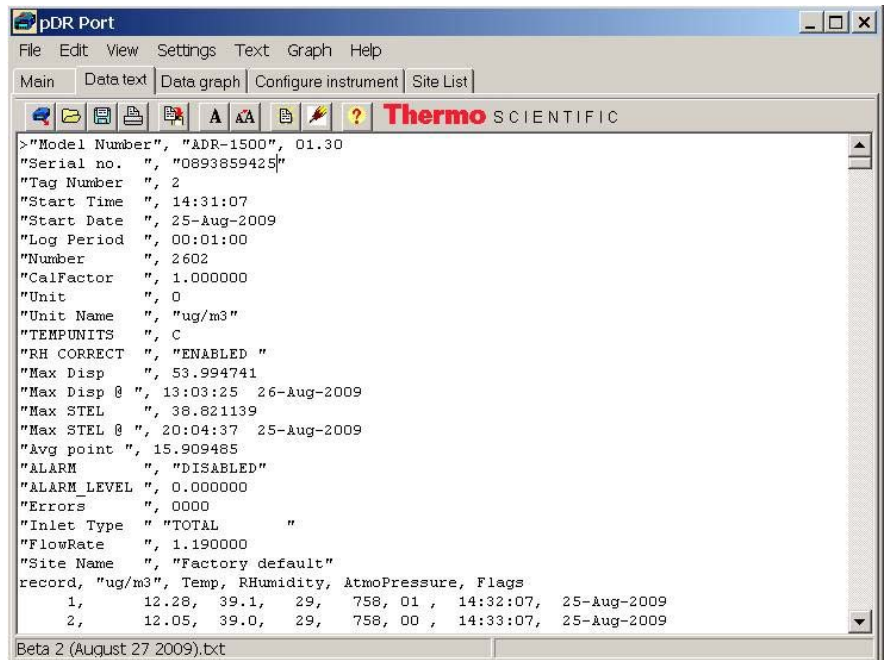



*Data graph.* This tab automatically plots the data from the Data text tab into a time series plot. Mass concentration or scattering coefficient, temperature, relative humidity and barometer pressure can all be plotted on this graph simultaneously or independently.

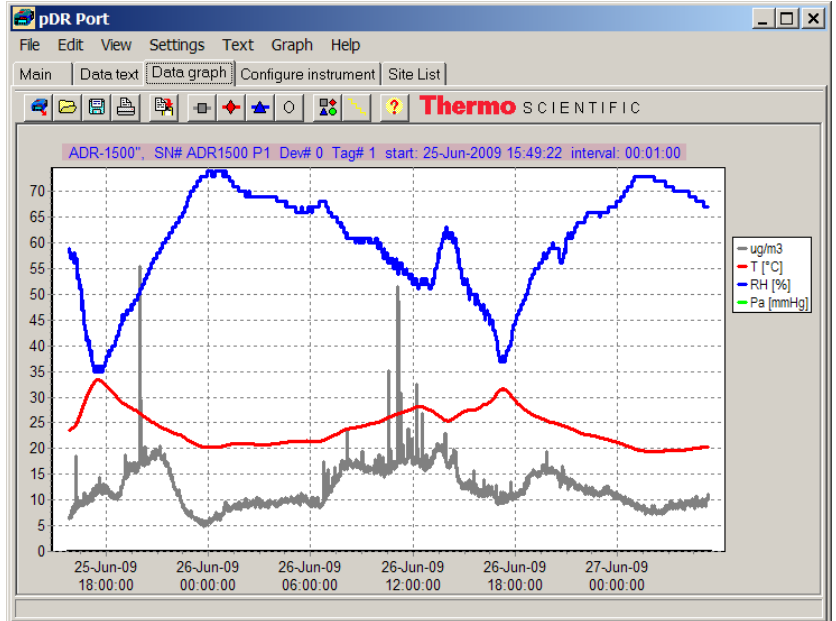

*Configure instrument.* This screen allows the user to edit the instrument configuration. Click on the item to be edited and select or type in the new value. To review the parameter values currently programmed into the ADR-1500, click on **Get current configuration**. After editing the parameters, click on **Set new configuration** to input the newly selected values into the ADR-1500.

*Site List.* This tab allows the user to retrieve, edit, and set the site list for the instrument. Site lists may also be read and written to a file on a computer.

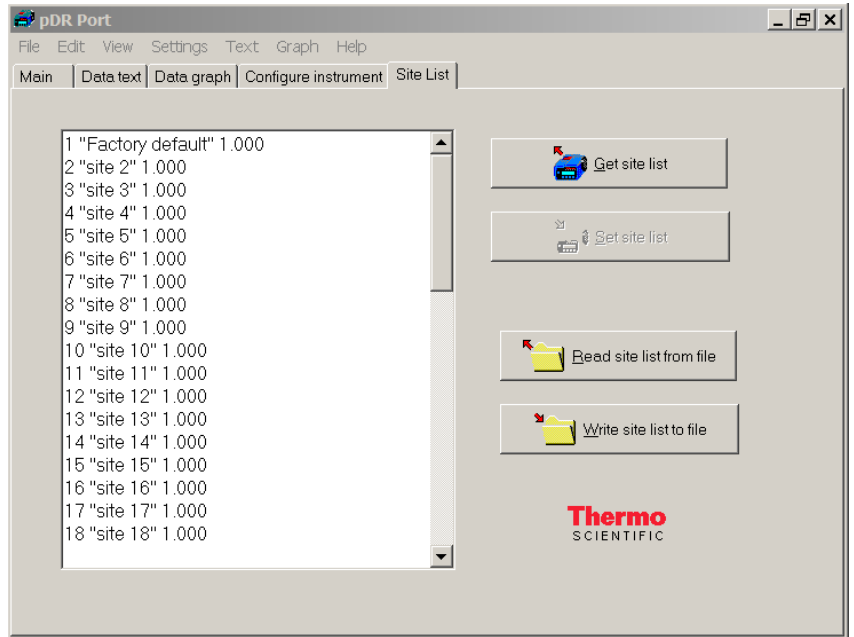

# Chapter 3

## Operation

This chapter describes the operating modes, keypad and screen cursor functions, menu-driven firmware, and starting a run. For details, see the following topics:

- [“Operating Modes”](#) on page 3-2
- [“Keypad and Screen Cursor Functions and Operation”](#) on page 3-3
- [“Operate Menu”](#) on page 3-6
- [“Configure Menu”](#) on page 3-14
- [“Calibrate Menu”](#) on page 3-24
- [“Starting a Run”](#) on page 3-28

## Operating Modes

The ADR-1500 has five modes of Operation:

1. *Start-up.* This is accomplished by holding the ON/OFF key for **4 seconds** whereby the splash screen will appear.
2. *Run Mode.* This is when the instrument is measuring aerosol and operating with an active flow rate. Normally the instrument is set for data logging to be enabled in this mode.
3. *Standby.* This is when the instrument is in an idle mode during which the user is interfacing with the instrument menu, configuring the instrument, downloading data, calibration, or when the instrument is set to begin sampling via an auto-start.
4. *Zeroing.* This mode is used to establish the optical background (Rayleigh scattering) of the ADR-1500. During this mode of operation the user is required to install a zeroing tube that connects the inlet stem to a HEPA filter.
5. *Shutdown.* Accomplished by holding the ON/OFF key until text on screen is no longer visible. The instrument is off.

# Keypad and Screen Cursor Functions and Operation

Before starting the ADR-1500, it is recommended that the user become familiar with the keypad functionality. There are three menus that outline the keypad functions and these are OPERATE, CONFIGURE, and CALIBRATE. Figure 3–1 below demonstrates the ADR-1500 menu structure. Following is a description of each menu.

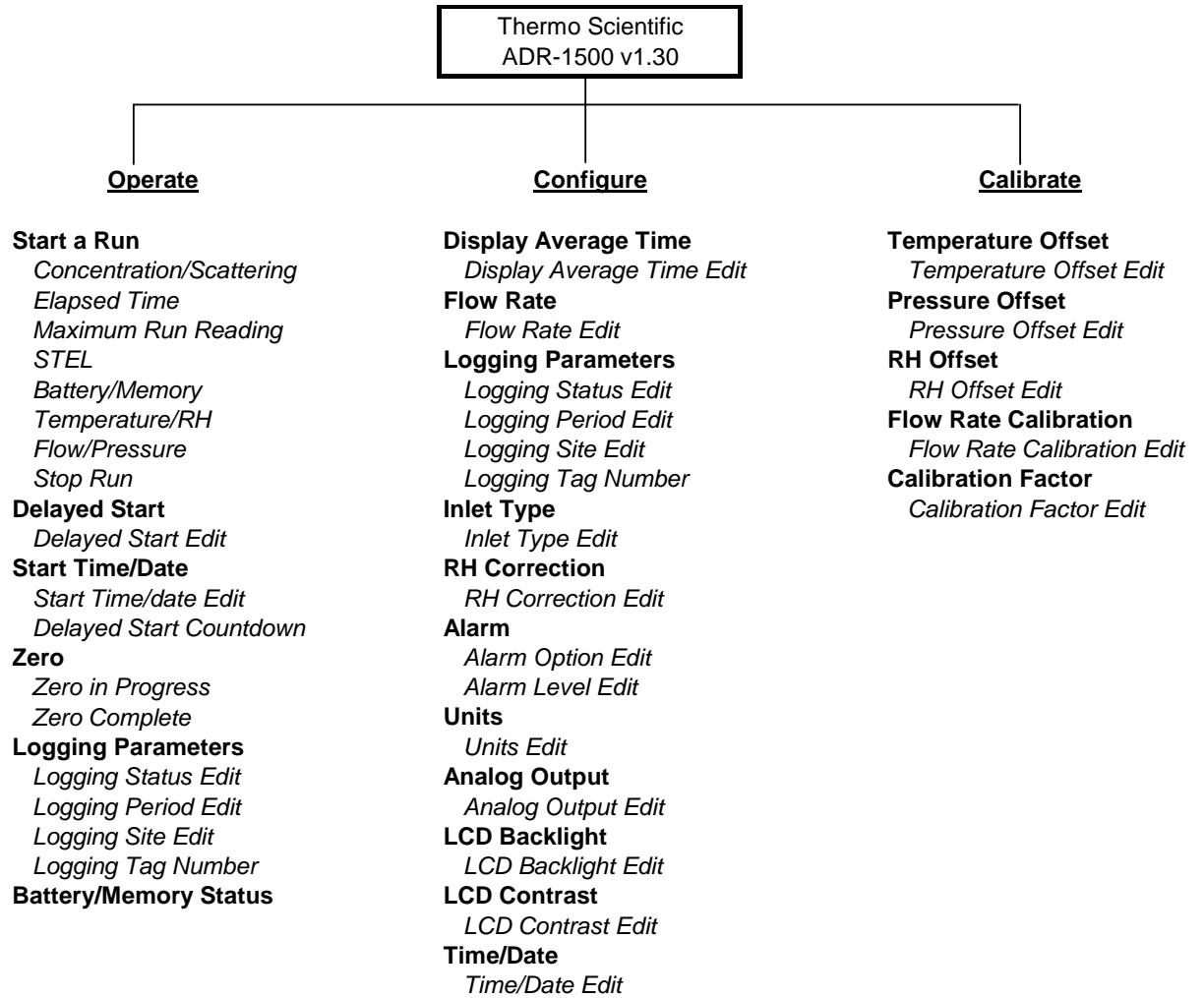

**Figure 3–1.** Keypad Overview

The Figure 3–2 below depicts the Operate Menu screen of the ADR-1500 after start-up and identifies the specific keys on the keypad.

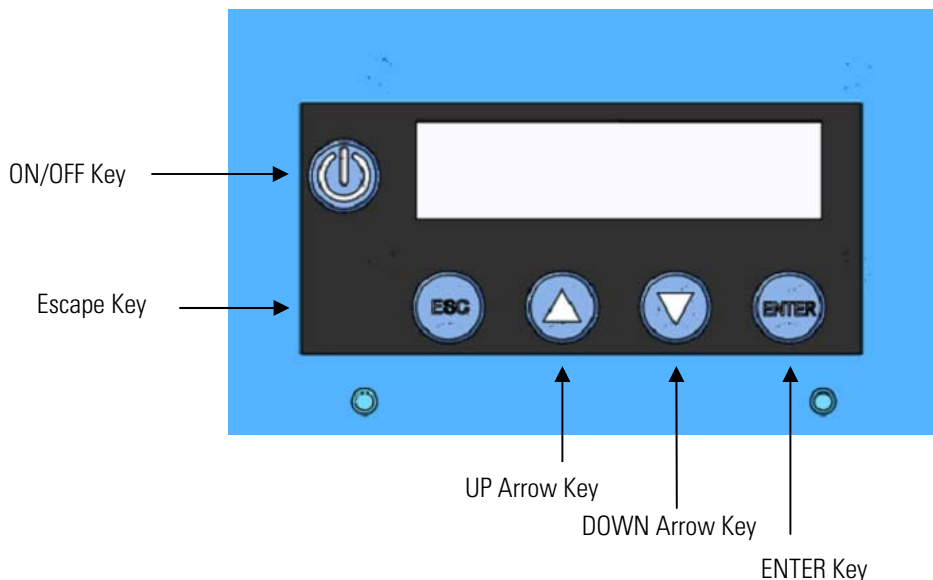

**Figure 3–2.** Keypad Functions

The equivalent of this screen is represented below, and this format will be used throughout the remainder of this Instruction Manual.

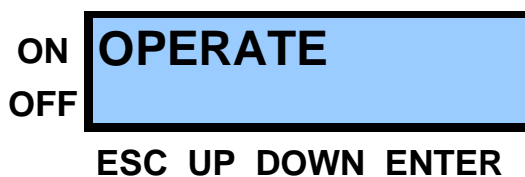

### Key Press Functions

The following is a general description of the key press functions:

- **ON/OFF** powers the instrument on or off. Press and hold ON/OFF for at least 4 seconds.
- **ESC** selects the display through which the current display was accessed (back up a level) or to bail out of an edit display without saving and return to the previous display from which the current display was assessed.
- **UP** (▲) scrolls through menu displays that are in a circular list (in a backward direction) or scrolls through values (also in a backward direction) in a display that is not part of a list (an edit display).

- **DOWN** ( ▼ ) scrolls through menu displays that are in a circular list (in a forward direction) or scrolls through values (also in forward direction) in a display that is not part of a list (an edit display).
- **ENTER** selects the function displayed on menu displays that are in a circular list, or used to exit and save the values as displayed in an edit display and return to the previous display from which the current display were accessed.

**Note** Holding down the ▲ or ▼ key will cause the rightmost digit to increase or decrease twice per second. After 5 seconds the next digit to the left will increase or decrease. Releasing the button returns control to the rightmost digit again. ▲

## Startup

To place the ADR-1500 into the Startup mode, press and hold the ON/OFF key for 4 seconds until you hear a beep followed by the Splash Screen appearing with the backlight on. The following splash screen appears:

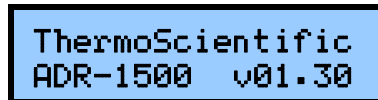

```
ThermoScientific
ADR-1500 v01.30
```

This screen appears for three seconds upon initiation of a power-up sequence, then default directly to the Operate Menu screen. In this screen you may scroll up or down to the Calibrate Menu or Configure Menu, respectively.

## Operate Menu

The Operate Menu is used to access the list of displays allowing the user to access the operating modes and run-time parameters of the ADR-1500 including “Start A Run”, “Delayed Start”, “Zero”, “Logging Parameters” and “Battery/Memory Status”.



## Start A Run

The Start A Run menu allows the user to begin monitoring/sampling. The run will be logged only if the asterisk (\*) appears at the end of the first display line (see below). If the ADR-1500 is ready to begin a monitoring run, press **ENTER** and the instrument will begin operating as configured.



**Equipment Damage** Verify that the exhaust port and the inlet port are not blocked. ▲

- From the Operate Menu, press the **ENTER** key and scroll the ▲ or ▼ key to the Start a Run screen.
- Press the **ENTER** key and the instrument will begin operating as configured.



Once a run is started, press the ▲ and ▼ keys to view a series of the following displays.

## Concentration/Scattering

The instrument measures concentration or scattering coefficient of  $\mu\text{g}/\text{m}^3$  for concentration or  $1/\text{Mm}$  for scattering coefficient. The real-time concentration is presented on the first line and the time-weighted average is presented on the second line. The real-time concentration is an average taken over a time interval called “Display Time”, which is programmed by the user. The presence of the asterisk (\*) in the first line indicates that data logging is enabled.



- From the Start a Run screen, press the **ENTER** key and scroll the ▲ or ▼ key to the Conc/Scat screen or press the **ESC** key to stop a run.

```

CONC  32.3*µg/m3
TWA   34.0 µg/m3

```

### Elapsed Time

The Elapsed Time screen allows the user to view the elapsed time in hours, minutes and seconds on the first line and the start time and date of the run on the second line. After ten seconds of key pad inactivity, the display will return to the concentration/scattering screen.

- From the Start a Run screen, press the **ENTER** key and scroll the ▲ or ▼ key to the ET screen or press the **ESC** key to stop a run.

```

ET 00000:07:12
08:15 13-Nov-09

```

### Maximum Run Reading

The MAX display screen allows the user to view maximum real-time reading (concentration or scattering coefficient) of the run and the time of occurrence. After ten seconds of key pad inactivity, the display will return to the concentration/scattering screen.

- From the Start a Run screen, press the **ENTER** key and scroll the ▲ or ▼ key to the Max screen or press the **ESC** key to stop a run.

```

MAX  56.4 ug/m3
08:26 13 Nov-09

```

### STEL

The STEL screen allows the user to view STEL maximum reading concentration or scattering coefficient. The STEL is based on the average of the last 15 minutes prior to the time of occurrence. After ten seconds of key pad inactivity, the display will return to the concentration/scattering screen.

- From the Start a Run screen, press the **ENTER** key and scroll the ▲ or ▼ key to the Stel screen or press the **ESC** key to stop a run.

```

STEL  34.1 ug/m3
08:30 13-Nov-09
    
```

### Battery/Memory

The Battery/Memory screen reads the battery voltage and the percentage of data logging memory left. After ten seconds of key pad inactivity, the display will return to the concentration/scattering screen.

- From the Start a Run screen, press the **ENTER** key and scroll the ▲ or ▼ key to the Battery/Memory screen or press the **ESC** key to stop a run.

```

BATTERY  12.6V
MEMORY LEFT  97%
    
```

### Temperature/RH

The Temperature/RH screen allows the user to view the current ambient temperature (degrees Celsius) and relative humidity. After ten seconds of key pad inactivity, the display will return to the concentration/scattering screen.

- From the Start a Run screen, press the **ENTER** key and scroll the ▲ or ▼ key to the Temp/RH screen or press the **ESC** key to stop a run.

```

TEMP  27.1 C
RHUM  41.4%
    
```

### Flow/Pressure

The Flow/Pressure screen allows the user to view the flow rate in liters per minute and the (ambient) atmospheric pressure in millimetres mercury. After ten seconds of key pad inactivity, the display will return to the concentration/scattering screen.

- From the Start a Run screen, press the **ENTER** key and scroll the ▲ or ▼ key to the Flow/Pres screen or press the **ESC** key to stop a run.

```

FLOW  2.000 LPM
PRES  750 mmHg
    
```

**Stop Run** The Stop Run screen offers the user to confirm that the run is to be stopped.

- From the Start a Run screen, press the **ENTER** key and scroll the ▲ or ▼ key to the Stop Run screen or press the **ESC** key to stop a run.
- Press the **Enter** key and the run is terminated.



STOP RUN?  
PRESS ENTER

**Delayed Start** The Delayed Start screen offers the user to view and edit the delayed start status as “enabled” or “disabled”.

- From the Operate menu, press the **ENTER** key and scroll the ▲ or ▼ key to the Delayed Start screen.



DELAYED START  
DISABLED

**Delayed Start Edit** The Delayed Start Edit screen allows the user to edit the delayed start as “enabled” or “disabled”. The asterisk (\*) appears to the left of the field being edited.

- From the Delayed Start screen, press the **ENTER** key to enable or disable a delayed start.



DELAYED START  
\* ENABLED

**Start Time/Date** The Start Time/Date screen allows the user to view and edit the delayed start time and date. The instrument will store the start time and date regardless of whether Delayed Start is enabled or disabled. If the start time and date is earlier than the current time, then it defaults to the current time.

- From the Operate menu, press the **ENTER** key and scroll the ▲ or ▼ key to the Start@ screen.

```
START@ 14:45:30
        13-Nov-09
```

### Start Time/Date Edit

The Start Time/Date Edit screen allows the user to edit the delayed start time and date. In the display, the **ENTER** and the **ESC** keys provide navigation through six fields within the display in the following sequence: hours, minutes, seconds, years, months, and days. The **ENTER** key navigates forward while the **Esc** key navigates backwards. The **▲** and **▼** keys are used to increment/decrement the field values. The asterisk (\*) appears to the left of the field being edited.

- From the Start@ screen, press the **ENTER** key and to advance to edit the next field, except if day (of month) is selected: the delayed start time and date saved, the delayed start status is enabled, and the display advances to Delayed Start Countdown.

```
START@ *14:45:30
        13-Nov-09
```

### Delayed Start Countdown

The Delayed Start Countdown screen displays the time of day that the ADR-1500 will start a run on the first line and the amount of time remaining before the instrument starts this run in days, hours, minutes, and seconds. The presence of the asterisk in the first line indicates that data logging is enabled.

```
START@ *14:45:30
120Days hh:mm:ss
```

### Zeroing the ADR-1500

The Zero Instrument screen is used to initiate a zero sequence to measure and store the optical background. The second line displays advice to the user that a filter must be applied to the Total Inlet to provide clean (particulate-free) air to the optics for this process.

- From the Operate menu, press the **ENTER** key and scroll the **▲** or **▼** key to the Zero Instrument screen.

**Note** Do not zero through the red or blue sharp-cut cyclones. Only zero through a clean Total Inlet. ▲



ZERO INSTRUMENT  
FILTER READY

### Zero In Progress

The Zeroing screen is shown while the ADR-1500 is performing a background measurement and optical signal offset adjustment, and key functions are different.

- From the Zero Instrument screen, press the **ENTER** key and the display advances to Zero in Progress (Zeroing).

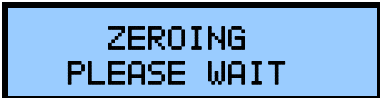

ZEROING  
PLEASE WAIT

**Note** Please be sure a HEPA filter is installed to a clean Total Inlet during this procedure to ensure proper measurements. Do not zero through the cyclones. ▲

### Zero Complete

After zeroing is complete, if the measurement was successful and within specification, the following screen appears. If the measurement was successful and outside of specification the instrument will respond with “COMPLETE: BKG HI”. If diagnostics indicated that measurement was compromised, the instrument will respond with “FAILURE 0x00ee”, where 0x00ee is a hex code indicating the type of error the diagnostic failure encountered during background measurement. Re-zero the instrument. After three attempts, contact customer service.



ZERO INSTRUMENT  
COMPLETE: BKG OK

### Logging Parameters

The Logging Parameters display screen indicates on the first line whether data logging is enabled or disabled. The second line of this screen displays the logging period for 3 seconds, displays site label for 3 seconds, and tag number for 3 seconds in sequence.

- From the Operate menu, press the **ENTER** key and scroll the ▲ or ▼ key to the Logging screen.

LOGGING ENABLED  
1:00:00 h:m:s

LOGGING ENABLED  
Factory default

LOGGING ENABLED  
01

### Logging Status Edit

The Logging Status Edit screen allows the user to enable or disable data logging. The asterisk (\*) appears to the left of the field being edited.

- From the Logging Parameters screen, press the **ENTER** key and the display advances to Logging Period Edit.
- Press the **ENTER** key enable or disable data logging.

LOGGING STATUS  
\* ENABLED

### Logging Period Edit

The Logging Period Edit screen allows the user to the logging period. The asterisk (\*) appears to the left of the field being edited. The ▲ and ▼ keys are used to increment/decrement the time. If either button is held, then the logging period will change twice per second but the editing focus will switch to the digit on the left after the button is held for five seconds.

- From the Logging Parameters screen, press the **ENTER** key and the display advances to Logging Period Edit.
- Press the **ENTER** key to enable or disable data logging.

LOGGING PERIOD  
\* 14:45:30 h:m:s

### Logging Site Edit

The Logging Site Edit screen allows the user to select from the list of 50 logging sites. Each site has three associated values: Site Number, a Site Name, and a Calibration Factor. The Site Name is the only value displayed

on the second line. Pressing the ▲ and ▼ keys changes the Site Number and the corresponding Site Name appears on the second line. Also, the corresponding Calibration Factor is chosen. The Site Numbers are in range (1, 2, 3..., 50), the Site Names and Calibration Factors are editable only by external serial command. The asterisk (\*) appears to the left of the field being edited.

- From the Logging Parameters screen, press the ENTER key and the display advances to Logging Period Edit.
- Press the ENTER key to save Site selection and forward to Logging Tag Number.

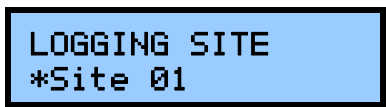

**Logging Tag Number**

The Logging Tag Number screen allows the user to select the tag no. (00, 01, 02...99), a number assigned to a logged run as label to access/retrieve the stored data. The asterisk (\*) appears to the left of the field being edited.

- From the Logging Parameters screen, press the ENTER key and the display advances to Logging Period Edit.
- Press the ENTER key to save Site selection and forward to Logging Tag Number.



**Battery/Memory Status**

The Battery/Memory Status screen reads the internal battery voltage on the first line and the percentage of the un-written memory on the second.

- From the Operate menu, press the ENTER key and scroll the ▲ or ▼ key to the Battery/Memory screen.



## Configure Menu

The Configure Menu is used to access the list of displays allowing the user to configure how the instrument measures and logs data including “Display Avg Time”, “Flow Rate”, “Logging Parameters”, “Inlet Type”, “RH Correction”, “Alarm”, “Units”, “Analog Output”, “LCD Backlight”, LCD Contrast” and “Time/Date”.



CONFIGURE

## Display Average Time

The Display Average Time screen offers the user to adjust the running (boxcar) average time of the displayed concentration (or scattering coefficient) between 1 and 60 seconds. The average concentration displayed is the value scaled to the analog output and offered as an alarm criterion.

- From the Configure menu, press the **ENTER** key and scroll the ▲ or ▼ key to the Display Avg Time screen.



DISPLAY AVG TIME  
10 seconds

## Display Average Time Edit

The Display Average Time Edit screen allows the user to change the running average displayed on the screen between 1 and 60 seconds. This also doubles as the running average that is provided as an analog output and also as one of the values that triggers the alarm. Use the ▲ and ▼ keys to increase or decrease the display average time by seconds. The asterisk (\*) appears to the left of the field being edited.

- From the Display Avg Time screen, press the **ENTER** key and edit the display averaging time.
- Press the **ENTER** key to save the display averaging time and return to Display Avg Time screen.



DISPLAY AVG TIME  
\* 11 seconds



### Flow Rate

The Flow Rate screen displays the set flow rate and the corresponding cyclone mass median diameter 50% cut point (D50).

- From the Configure menu, press the **ENTER** key and scroll the ▲ or ▼ key to the Flow Rate screen.



### Flow Rate Edit

The Flow Rate Edit screen allows the user to edit the volumetric flow rate. The flow range is 1–3.5 L/min and if a cyclone has already been chosen, the corresponding 50% aerodynamic cut point (D50 in micrometers) will change simultaneously. Use the ▲ and ▼ keys to increase or decrease the flow rate in increments of 0.01 LPM. The asterisk (\*) appears to the left of the field being edited.

- From the Flow Rate screen, press the **ENTER** key and edit the flow rate.
- Press the **ENTER** key to save the flow rate and return to the Flow Rate screen.



### Logging Parameters

The Logging Parameters display screen indicates on the first line whether data logging is enabled or disabled. The second line of this screen displays the logging period for 3 seconds, the site label for 3 seconds, and the tag number for 3 seconds in sequence.

- From the Configure menu, press the **ENTER** key and scroll the ▲ or ▼ key to the Logging screen.





### Logging Status Edit

The Logging Status Edit screen allows the user to enable or disable data logging. The asterisk (\*) appears to the left of the field being edited.

- From the Logging Parameters screen, press the **ENTER** key and edit the logging status.
- Press the **ENTER** key to save the logging status and forward to the Logging Period edit.



### Logging Period Edit

The Logging Period Edit screen allows the user to edit the logging period. The asterisk (\*) appears to the left of the field being edited. Use the ▲ and ▼ keys to increment or decrement the time. If either button is held, then the logging period will change twice per second but the editing focus will switch to the digit on the left after the button is held for five seconds.

- From the Logging status screen, press the **ENTER** key to edit the logging period.
- Press the **ENTER** key to save the logging period and forward to the Logging Site edit.



### Logging Site Edit

The Logging Site Edit screen allows the user to select from the list of 50 logging sites. Each site has three associated values: Site Number, a Site Name, and a Calibration Factor. The site name is the only value displayed on the second line. Use the ▲ and ▼ keys to change the site number and the corresponding site name appears on the second line. Also, the corresponding calibration factor is chosen. The site numbers are in range (1, 2, 3..., 50), the site names and calibration factors are editable only by external serial command. The asterisk (\*) appears to the left of the field being edited.

- From the Logging Period screen, press the **ENTER** key to edit the logging site.
- Press the **ENTER** key to save the logging period and forward to the Logging Site edit.

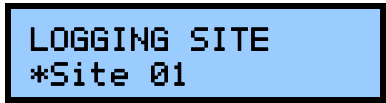

**Logging Tag Number**

The Logging Tag Number screen allows the user to select the tag no. (00, 01, 02...99), a number assigned to a logged run as label to access/retrieve the stored data. The asterisk (\*) appears to the left of the field being edited.

- From the Logging Site screen, press the **ENTER** key to edit the logging tag number.
- Press the **ENTER** key to save Site selection and return to the Logging Parameters display screens.



**Inlet Type**

The Inlet Type screen allows the user to select the inlet type being used (Red, Cyclone, or Total).

- From the Configure menu, press the **ENTER** key and scroll the ▲ or ▼ key to the Inlet Type screen.

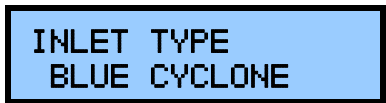

**Inlet Type Edit**

The Inlet Type Edit screen allows the user to select the type of inlet being used. Inlet types are: Cyclone, Blue Cyclone or Total Inlet. Use the ▲ and ▼ keys to change the inlet type. The asterisk (\*) appears to the left of the field being edited.

- From the Inlet Type screen, press the **ENTER** key to edit the inlet type.
- Press the **ENTER** key to save the inlet type and return to the Inlet Type screen.

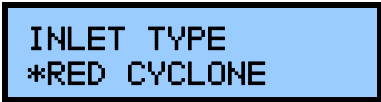

### RH Correction

The RH Correction screen allows the user to view whether RH correction is enabled or disabled.

- From the Configure menu, press the **ENTER** key and scroll the ▲ or ▼ key to the RH Correction screen.



**Note** RH Correction should be enabled when the RH is expected to exceed 50–60%. Ambient monitoring should always use the RH Correction as being enabled. However, precision can be affected between collocated devices. ▲

### RH Correction Edit

The RH Correction Edit screen allows the user to enable or disable RH correction. The asterisk (\*) appears to the left of the field being edited

- From the RH Correction screen, press the **ENTER** key to edit the RH correction.
- Press the **ENTER** key to save the RH correction and return to the RH Correction screen.



### Alarm

The Alarm screen indicates the alarm options for triggering the alarm (Disabled, Instant, or STEL) and the value at which it is triggered. The instant setting causes the alarm to be triggered when the displayed concentration is higher than the instant alarm level setting. The STEL setting causes the alarm to be triggered when the 15 minute rolling (boxcar) average is higher than the STEL alarm level setting. Each of the two enabled alarm options use separately stored alarm level values.

**Note** The units mg/m<sup>3</sup> are replaced with /km when the ADR-1500 is measuring scattering coefficient, using the units 1/Mm. ▲

- From the Configure menu, press the ENTER key and scroll the ▲ or ▼ key to the Alarm screen.

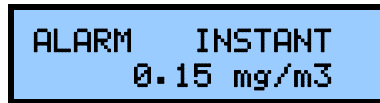

**Alarm Option Edit**

The Alarm Option Edit screen allows the user to edit the alarm. Alarm options are: Instant, STEL, or Disabled. Use the ▲ and ▼ keys to change the alarm option. The asterisk (\*) appears to the left of the field being edited.

- From the Alarm screen, press the ENTER key and edit the alarm option.
- Press the ENTER key to save the alarm option and forward to the Alarm Level edit screen.



**Alarm Level Edit**

The Alarm Level Edit screen allows the user to edit the alarm for which the alarm is triggered. Use the ▲ and ▼ keys to increase or decrease the alarm level by 0.01 mg/m<sup>3</sup>. The asterisk (\*) appears to the left of the field being edited.

- From the Logging status screen, press the ENTER key to edit the alarm level.
- Press the ENTER key to save the alarm option and return to the Alarm screen.

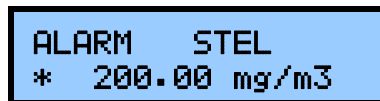

**Units**

The Units screen allows the selection of units from micrograms per cubic meter (µg/m<sup>3</sup>) or to a measure of the aerosol scattering coefficient in units of inverse mega meters (1/Mm).

**Note** When the units /Mm are chosen, the RH correction becomes automatically disabled. ▲

- From the Configure menu, press the **ENTER** key and scroll the ▲ or ▼ key to the Units edit screen.

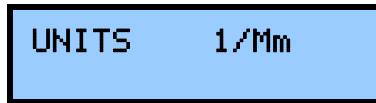

**Units Edit**

The Units Edit screen allows the user to change the option for units. Use the ▲ and ▼ keys to toggle between the two unit options. The asterisk (\*) appears to the left of the field being edited.

- From the Units screen, press the **ENTER** key to edit the units.
- Press the **ENTER** key to save the units and return to the Units screen.

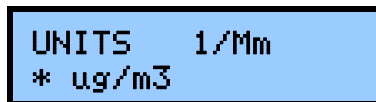

**Analog Output**

The Analog Output screen indicates the status of the analog output (enabled/disabled) and offers the user the option to enable or disable the analog output and change the analog span range in corresponding units of measure ( $\mu\text{g}/\text{m}^3$  or 1/Mm). The proportional voltage output range is 0–2 VDC for the analog output.

- From the Configure menu, press the **ENTER** key and scroll the ▲ or ▼ key to the Analog Output screen.



**Analog Output Edit**

The Units Edit screen allows the user to configure the analog output. The values offered for selection are compatible with the selected units. The values offered for /Mm (scattering coefficient) are: disabled, 10/Mm, 100/Mm, 1000/Mm, 10000/Mm, and 100000/Mm. The values offered for  $\mu\text{g}/\text{M}^3$  (concentration) are: disabled, 0.10  $\text{mg}/\text{m}^3$ , 0.40  $\text{mg}/\text{m}^3$ , 1.00  $\text{mg}/\text{m}^3$ , 4.00  $\text{mg}/\text{m}^3$ , 10.0  $\text{mg}/\text{m}^3$ , 40  $\text{mg}/\text{m}^3$ , 100  $\text{mg}/\text{m}^3$ , 400  $\text{mg}/\text{m}^3$ , and

1000 mg/m<sup>3</sup>. Use the ▲ and ▼ keys to cycle through the list of analog output items. The asterisk (\*) appears to the left of the field being edited.

- From the Analog Output screen, press the **ENTER** key to edit the analog output.
- Press the **ENTER** key to save the analog output selection and return to the Analog Output screen.



### LCD Backlight

The LCD Backlight screen displays whether the backlight is enabled or disabled and offers the user to choose whether to enable or disable the LCD backlight. If the backlight is enabled and the instrument is running solely from battery power, the backlight will come on for a period of 10 seconds after each keystroke. Thereafter, the backlight will automatically shut off in an effort to conserve power. If running on external power supply, the LCD backlight stays on.

- From the Configure menu, press the **ENTER** key and scroll the ▲ or ▼ key to the LCD Backlight screen.



### LCD Backlight Edit

The LCD Backlight Edit screen allows the user to enable or disable the LCD backlight. Use the ▲ and ▼ keys to toggle between enable or disable. The asterisk (\*) appears to the left of the field being edited.

- From the LCD Backlight screen, press the **ENTER** key to edit the LCD backlight.
- Press the **ENTER** key to save the LCD backlight status and return to the LCD Backlight screen.



## LCD Contrast

The LCD Contrast screen allows the user to view and edit the contrast of the display. Lower settings darken the contrast and make the display more readable at colder temperatures. Higher settings lighten the contrast and make the display more readable at warmer temperatures. The nominal setting is 25.

- From the Configure menu, press the **ENTER** key and scroll the ▲ or ▼ key to the LCD Contrast screen.



## LCD Contrast Edit

The LCD Contrast Edit screen allows the user to edit the contrast of the display. Use the ▲ and ▼ keys to increment or decrement the LCD contrast. The asterisk (\*) appears to the left of the field being edited.

- From the LCD Contrast screen, press the **ENTER** key to edit the LCD contrast.
- Press the **ENTER** key to save the LCD contrast status and return to the LCD Contrast screen.



## Time/Date

The Time/Date screen displays the current time and date and offers the user to re-program the time and date.

- From the Configure menu, press the **ENTER** key and scroll the ▲ or ▼ key to the Time/Date screen.

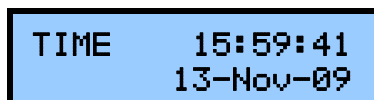

## Time/Date Edit

The Time/Date Edit screen allows the user to edit the current time and date. The Start Time/Date Edit screen allows the user to edit the delayed start time and date. In the display, the **ENTER** and the **ESC** keys provide



navigation through six fields within the display in the following sequence: hours, minutes, seconds, years, months, and days. The **ENTER** key navigates forward while the **Esc** key navigates backwards. The **▲** and **▼** keys are used to increment/decrement the field values. The asterisk (\*) appears to the left of the field being edited.

- From the Time/Date screen, press the **ENTER** key to and to advance to edit the next field.
- Press the **ENTER** key to save the time/date and return to the Time/Date screen.

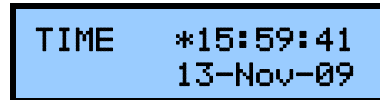

```
TIME *15:59:41
      13-Nov-09
```

## Calibrate Menu

The Calibrate Menu is used to access the list of displays allowing the user to calibrate the sensors used to measure scattering, temperature, relative humidity, barometric pressure, flow rate, and the time and date. The displays include “Temp Offset”, “Pressure Offset”, “RH Offset”, “Flow Rate Cal”, and “Cal Factor”.



## Temperature Offset

The Temperature Offset screen allows the user to view and edit the temperature offset of the measurement to coincide with their traceable standards.

- From the Calibrate Menu, press the **ENTER** key and scroll the ▲ or ▼ key to the Temp Offset screen.



## Temperature Offset Edit

The Temperature Offset Edit screen allows the user to edit the temperature offset. Use the ▲ and ▼ keys to increase or decrease the user temperature offset in increments of 0.1 in degrees Celsius. The asterisk (\*) appears to the left of the field being edited.

- From the Temp Offset screen, press the **ENTER** key and edit the temperature offset.
- Press the **ENTER** key to save the temperature offset and return to Temp Offset screen.



Please note that a precise and accurate calibration of the RH-sensor is critical to maintaining precision between collocated devices when using RH Correction enabled.

## Pressure Offset

The Pressure Offset screen allows the user to view and edit the pressure offset of the barometric pressure measurement to coincide with their traceable standards.

- From the Calibrate Menu, press the **ENTER** key and scroll the ▲ or ▼ key to the Pressure Offset screen.



PRESSURE OFFSET  
0 760 mmHg

## Pressure Offset Edit

The Pressure Offset Edit screen allows the user to edit the pressure offset. Use the ▲ and ▼ keys to increase or decrease the user pressure offset in increments of 1 in millimetres of mercury. The asterisk (\*) appears to the left of the field being edited.

- From the Pressure Offset screen, press the **ENTER** key and edit the pressure offset.
- Press the **ENTER** key to save the user pressure offset and return to Pressure Offset screen.



PRESSURE OFFSET  
\* 10 750 mmHg

## RH Offset

The RH Offset screen allows the user to view and edit the RH offset of the barometric pressure measurement to coincide with their traceable standards.

- From the Calibrate Menu, press the **ENTER** key and scroll the ▲ or ▼ key to the RH Offset screen.



RH OFFSET  
0.0 47.3 %

## RH Offset Edit

The RH Offset Edit screen allows the user to edit the RH offset. Use the ▲ and ▼ keys to increase or decrease the RH offset in increments of 0.1% RH. The asterisk (\*) appears to the left of the field being edited.

- From the RH Offset screen, press the **ENTER** key and edit the RH offset.
- Press the **ENTER** key to save the user RH offset and return to the RH Offset screen.



## Flow Rate Calibration

The Flow Rate Calibration screen allows the user the option to perform a multi-point inlet flow calibration.

- From the Calibrate Menu, press the **ENTER** key and scroll the ▲ or ▼ key to the Flow Rate Cal screen.



## Flow Rate Calibration Edit

The Flow Rate Calibration Edit screen allows the user to calibrate the six flow control settings and define the flow rate at each flow control setting. This will build a table of the six calibration point to be used for interpolating the flow control setting to achieve the flow rate set in the Configure menu's "Flow Rate Edit".

The flow rate calibration is accomplished in a sequence of six displays for six flow calibration points, setting the six flow control settings for the corresponding six defined flow rate setting. The **ENTER** and **ESC** keys are used to navigate through the edit fields, while the ▲ and ▼ keys are used to increase and decrease the values. The asterisk (\*) appears to the left of the field being edited.

For factory settings, the flow control adjust is adjusted for flow calibration points (1, 2, 3, 4, 5, and 6) to produce corresponding defined flow rates (1.00, 1.50, 2.00, 2.50, 3.00, and 3.50 liters per minute) and the defined flow rates are kept at the factory default setting. The user may, however, redefine the defined flow rate for each flow calibration point to get a more accurate calibration. However, the defined flow rate values must increase in value as the flow calibration point increases.

In the following screen there are two values shown; ADJ = 188 and LPM = 1.00. In this screen the 188 is the pump speed control value used to achieve 1.00 L/min. The user may adjust the motor speed to achieve 1.00 L/min or

may adjust the measured inlet flow rate that is equal at that pump speed. After pressing the **ENTER** key, the next calibration point is pursued.

**Note** Should the temperature and pressure be re-calibrated, the accuracy of the flow calibration should be verified. ▲

- From the Flow Rate Cal screen, press the **ENTER** key to navigate forward, until last step (flow calibration point 6, defined flow rate) the display returns to the Flow Rate Cal screen and the new calibration is saved only if at least one of the values was edited.



FLOW RATE CAL 1  
ADJ\* 188LPM:1.00

## Calibration Factor

The Calibration Factor screen shows the site number selected and allows the user to edit the calibration factor for that site number. The calibration factor is the value used to scale the concentration output to agree with a primary calibration or user defined standard.

In the following screen, the ADR-1500 shows the instrument is operating for Site 1, and the Calibration Factor is 1.000 which will provide a 1:1 response with the factory calibration. For more information about calibration, see Chapter 4, “[Calibration and Particle Size Selection](#)”.

- From the Calibrate Menu, press the **ENTER** key and scroll the ▲ or ▼ key to the Cal Factor screen.



CAL FACTOR 1  
1.000

## Calibration Factor Edit

The Calibration Factor Edit screen allows the user to edit the calibration factor values. Use the ▲ and ▼ keys to increase or decrease the value by 0.001. The asterisk (\*) appears to the left of the field being edited.

- From the Cal Factor screen, press the **ENTER** key and edit the values.
- Press the **ENTER** key to save the calibration factor associated with the site number and return to Cal Factor screen.



CAL FACTOR 2  
\* 1.000

## Starting a Run

The following provides a brief overview of how to start a monitoring and sampling run.

## Filter Requirements

Before starting a run, a HEPA filter or optional 37-mm filter must be inserted downstream of the optical assembly. The recommended 37-mm filters are glass microfibre filters. If using the 5-micron PVC filters, use the glass microfibre filters as a backing media when using battery power.



**Equipment Damage** At no time should the ADR-1500 be running without a filter in place, otherwise serious damage to the internal components may result. ▲

## ZERO/Initialize Operation

Before initiating a measurement run it is advisable to perform the zeroing and automatic internal check out sequences, to ensure optimal operation.

- From the Operate menu, press the **ENTER** key and scroll the ▲ or ▼ key to the Zero Instrument screen.



ZERO INSTRUMENT  
FILTER READY

Attach a HEPA filter to the Total Inlet and press **ENTER**. Do not zero through the cyclone.

During zeroing, each range within the auto-ranging potential is used to measure the optical background of the instrument and each value is stored for subsequent data calculations. The duration of a Zero Operation is usually 2-3 minutes. After Zeroing is complete, the following screen should be present:



ZERO INSTRUMENT  
COMPLETE: BKG OK

- From the Zero Instrument screen, by pressing the ▼ key, the user proceeds to a series of logging screens in the following order:

```
LOGGING ENABLED
1:00:00 h:m:s
```

```
LOGGING ENABLED
Factory default
```

```
LOGGING ENABLED
01
```

In the screens above, by pressing the **ENTER** key, the user can edit the logging tag number, the logged averaging period, and the logging site name.

### Auto-Start (Optional)

The desired time and date for the automatic start of a run and data logging can be selected as described previously. This feature is optional.

- From the Operate menu, press the **ENTER** key and scroll the ▲ or ▼ key to the Start@ screen.

```
START@ 14:45:30
13-Nov-08
```

In this screen, the user can press **ENTER** to alter a delayed start time and date for the ADR-1500. If this feature is selected, the instrument will remain in Standby mode until the current time reaches the start time.

### Configuration Review

In addition to the description of the “[Configure Menu](#)” earlier in this chapter, the configuration of the instrument should be reviewed prior to beginning a run.

In addition to assuring that the data logging features are set, the three most important configuration settings to review are the:

- Inlet Type – Total, Red Cyclone, or Blue Cyclone
- The Flow Rate and respective D50 cut-point, and
- The Enabling or Disabling of the RH Correction

The inlet type, flow rate, and respective particle cut-point (D50) are described in “Particle Size Cut Points” on page 4-5.

- From the Configure menu, press the ENTER key and scroll the ▲ or ▼ key to the Inlet Type screen.

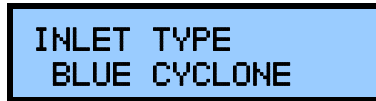

In the above screen, the Inlet Type is shown. By pressing ENTER, the inlet can be changed from Total to Red Cyclone or Blue Cyclone. If a cyclone is selected, the D50 cut-point will change depending upon the flow rate selected.

When the relative humidity correction function is enabled, the particle growth effect due to a high humidity environment is corrected for. This means that the computed mass concentration is based on the original dry environment particle population. This correction only applies when mass concentration units have been selected, but not when scattering coefficient has been selected.

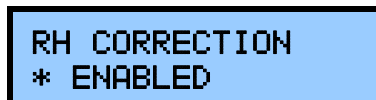

As with any light scattering device, the scattering efficiency of an aerosol will increase with an increased relative humidity. Furthermore, the scattering efficiency of a particle is maximized when the particle diameter is the same as the wavelength of the incident light. In the case of the ADR-1500 an 880 nm LED light source is used and a RH Correction has been implemented based on data taken from multiple field evaluations. When enabled, the ADR-1500 will normalize the response to a relative humidity of 40% when the measured RH > 40 %. Although the RH Correction is effective at providing a more accurate response, the connector can affect the precision between two instruments.

Additional Configuration parameters are the Alarm setting, units of measure, and the Analog Output settings.

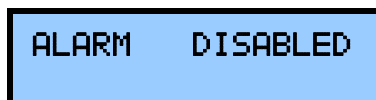



By pressing the **ENTER** Key, the user can enable the Alarm whereby the concentration required to trigger the alarm can be adjusted from 0.01 – 200 mg/m<sup>3</sup>.

```

UNITS    ug/m3
  
```

In the screen above, the units of measure can be changed from either micrograms per cubic meter ( $\mu\text{g}/\text{m}^3$ ) to a measure of the aerosol scattering coefficient in units of inverse megameters (1/Mm), whereby the RH Correction should become automatically disabled.

```

ANALOG OUTPUT
DISABLED
  
```

The user can enable or disable the analog output and change the analog span range in corresponding units of measure ( $\mu\text{g}/\text{m}^3$  or 1/Mm). The voltage output range is 0-2 VDC for the analog output. The Analog output settings are 0 - 0.1, 0 - 0.4, 0 - 1.0, 0 - 4.0, 0 - 10, 0 - 40, 0 - 100, 0 - 400, and 0 - 1,000 mg/m<sup>3</sup>.

The last configuration screen is to set the time. This screen is used to set the time and date, should these require resetting.

```

TIME      15:59:41
          13-Nov-09
  
```

In the screen above the current time and date are displayed and may be adjusted as necessary. The first line indicates the time presently registered by the ADR-1500. The second is the present date registered by the ADR-1500.

To set the time accurately, press **ENTER** and a flashing asterisk (\*) will appear to the left of the character to change. Adjust the value using the up and down keys and press **ENTER**. The asterisk will move throughout the screen to adjust each respective value.

In the U.S., it is convenient to dial 1-900-410-8463 (U.S. Naval Observatory time information), and at the instant when the time

announced equals the time preset on the second line of the above screen, key **ENTER**, as instructed on the last line.

## Start the Run

To start the run, press **ENTER** from the Operate menu.

- From the Operate Menu, press the **ENTER** key and scroll the ▲ or ▼ key to the Start a Run screen.



In this screen, the ADR-1500 prompts the user regarding the valve, which is just an assurance that the exhaust port and the inlet port are not blocked. If the ADR-1500 is ready to begin a monitoring run, press **ENTER** and the instrument will begin operating as configured.

It should be remembered that the measurement units can only be selected in the set-up mode and not during a run.

# Chapter 4

## Calibration and Particle Size Selection

The following sections discuss the calibration process and procedures for calibrating the instrument:

- [“Factory Calibration”](#) on page 4-2
- [“How to Apply a Correction Factor”](#) on page 4-3
- [“Particle Size Cut Points”](#) on page 4-5
- [“Continuous Unattended Monitoring”](#) on page 4-6

## Factory Calibration

For mass concentration measurements, each ADR-1500 is factory calibrated against a set of reference monitors that, in turn, are periodically calibrated against a gravimetric standard traceable to the National Institute of Standards and Testing (NIST).

The primary factory reference method consists of generating a dust aerosol by means of a fluidized bed generator, and injecting continuously the dust into a mixing chamber from which samples are extracted concurrently by two reference filter collectors and by two master real-time monitors that are used for the routine calibration of every ADR-1500.

The primary dust concentration reference value is obtained from the weight increase of the two filters due to the dust collected over a measured period of time, at a constant and known flow rate. The two master real-time monitors are then adjusted to agree with the reference mass concentration value (obtained from averaging the measurements of the two gravimetric filters) to within  $\pm 1\%$ .

Three primary NIST traceable measurements are involved in the determination of the reference mass concentration: the weight increment from the dust collected on the filter, the sampling flow rate, and the sampling time. Additional conditions that must be met are: a) suspended dust concentration uniformity at all sampling inlets of the mixing chamber; b) identical sample transport configurations leading to reference and instrument under calibration; and c) essentially 100% collection efficiency of filters used for gravimetric reference for the particle size range of the test dust.

The test dust used for the factory calibration of the ADR-1500 is SAE Fine (ISO Fine) supplied by Powder Technology, Inc. It has the following physical characteristics (as dispersed into the mixing chamber):

- Mass median aerodynamic particle diameter: 2 to 3  $\mu\text{m}$
- Geometric standard deviation of lognormal size distribution: 2.5
- Bulk density: 2.60 to 2.65  $\text{g}/\text{cm}^3$
- Refractive index: 1.54

In addition to the mass calibration described above, the ADR-1500 is factory calibrated for temperature, relative humidity, barometric pressure, and volumetric flow rate using NIST-traceable standards.

## How to Apply a Correction Factor

If desired, the ADR-1500 can be calibrated gravimetrically for a particular aerosol (dust, smoke, mist, etc.), other than SAE Fine, under field conditions (actual conditions of use). To effect such calibration in the particle environment of interest, proceed as indicated below:

- Place the ADR-1500 within the particle environment.
- Start a run.
- After 1-minute, record the time weighted average (TWA).
- Calculate the run time (t) necessary to collect at least 1 milligram of sample using the following equation:

$$(t) = \frac{500}{TWA}$$

For example, if the 1-minute TWA = 2.5 mg/m<sup>3</sup>, the run time necessary to collect approximately 1 mg of sample equals 200 minutes (i.e., t = 200 minutes).

Now that the run time (t) has been calculated from the above 1-minute preliminary test, proceed with the following steps using the optional 37-mm filter assembly:

- Perform a tare weight on a fresh 37-mm filter using a microbalance with at least a 0.001 mg resolution and place into the filter assembly.
- Record the tare weight (m<sub>1</sub>).
- Load the filter assembly into the ADR-1500 in place of the large capacity HEPA filter.
- Place the ADR-1500 within the particle environment of choice
- Start a run using a 1-minute data logging.
- Allow the ADR-1500 to run for the run time calculated from the preliminary test (e.g., t = 200 minutes).
- At the end of the run, record the TWA (mg/m<sup>3</sup>) run time t (minutes) and flow rate (LPM).
- Stop the run.
- Recover the 37-mm filter assembly from the instrument and return to the microbalance room for weighing.
- Remove the 37-mm filter from the assembly, and weigh the filter after equilibration and anti-static neutralization, as necessary.

- Record the filter gross weight ( $m_2$ ).
- Calculate the mass increment ( $\Delta m$ ) due to the collected particles, as follows:

$$\Delta m = m_2 - m_1$$

With the net mass ( $\Delta m$ ) recorded in unit of milligrams, run time ( $t$ ) recorded in minutes, and flow rate ( $Q$ ) recorded in liters per minute, calculate the average gravimetric concentration  $C$ , as follows:

$$C = \left( \frac{1,000 * \Delta m}{t \bullet Q} \right)$$

Now compare the recorded TWA from the ADR-1500 and the calculated gravimetric particulate mass concentration ( $C$ ) and calculate the calibration factor to be programmed into the ADR-1500 site list as follows:

$$CAL FACTOR = \frac{C}{TWA}$$

For example, if  $C$  was found to be  $3.2 \text{ mg/m}^3$ , and TWA had been determined to be  $2.5 \text{ mg/m}^3$ , the CAL FACTOR equals 1.28. The user can now edit this value on the ADR-1500 calibration screen through the use of pDR Port or via the keypad.

## Site Calibration Factors

The Cal-Factors calculated from the above comparison can be stored via pDR Port into the ADR-1500. The ADR-1500 holds up to 50 different site names. Each site name has a default Cal-Factor of 1.000. The Cal-Factor of each site can be adjusted either through the Menu Interface or through the pDR Port user interface.

## Particle Size Cut Points

The ADR-1500 has three different inlets to choose from Total Inlet, Red Cyclone, and Blue Cyclone.

The Total Inlet is a standard accessory for the ADR-1500 and is designed for use as a total aerosol mass measurement. When operated in a flow range of 1-2 L/min with a tared 37-mm 5- $\mu$ m PVC filter, NIOSH Method 0500 can be achieved in addition to the real-time measurements.

The Red Cyclone is an optional ACGIH-traceable cyclone that is used primarily for establishing an aerodynamic diameter 50% cut point between 4 to 10 micrometers. When used at a flow rate of 2.65 L/min with a tared 37-mm 5- $\mu$ m PVC filter, NIOSH Method 0600 can be achieved in addition to the real-time measurements.

The Blue Cyclone is an optional ACGIH-traceable cyclone that is used primarily for establishing an aerodynamic diameter 50% cut point between 1 to 4 micrometers.

The Red and Blue Cyclones have the following 50% AED cut-point characteristics shown in [Figure 4-1](#).

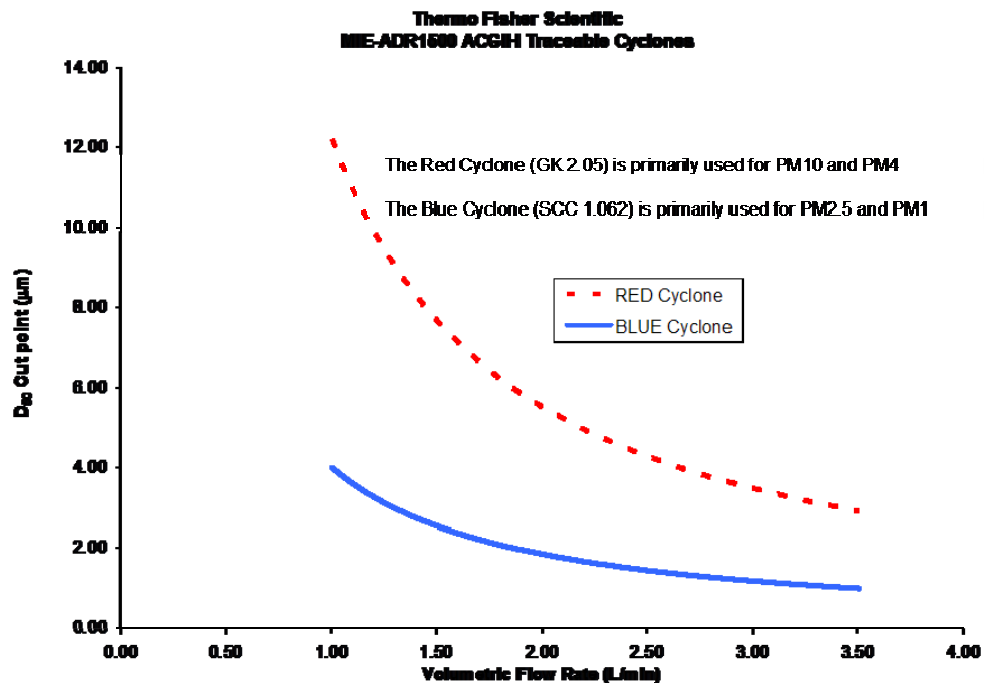

Figure 4-1. Cyclone D50 Curves

## **Continuous Unattended Monitoring**

When the ADR-1500 is used for continuous unattended monitoring (e.g., ambient air monitoring), the optional 37-mm filter holder should not be used. Rather, the large capacity HEPA filter should be used in its place, which will require replacement on an infrequent schedule (see Chapter 5 “[Maintenance and Service](#)” of this manual).



# Chapter 5

## Maintenance and Service

This chapter describes the periodic maintenance procedures that should be performed on the instrument to ensure proper operation. Since usage and environmental conditions vary greatly, the components should be inspected frequently until an appropriate maintenance schedule is determined.

This chapter includes the following preventive maintenance information:

- “General Guidelines” on page 5-2
- “Replacement Parts List” on page 5-3
- “Instrument Storage” on page 5-6
- “Cleaning of Optical Sensing Chamber” on page 5-7
- “Removing the Internal Cover” on page 5-8
- “LCD Assembly Replacement” on page 5-10
- “Pump Assembly Replacement” on page 5-12
- “Communications PCB Replacement” on page 5-14
- “Optics Enclosure Assembly Removal” on page 5-18
- “Heater Switch Assembly Replacement” on page 5-20
- “Battery Use” on page 5-23
- “Lead Acid Battery Replacement” on page 5-24
- “In-Line Flow Meter Filter with Fittings Replacement” on page 5-26
- “Extended Monitoring HEPA Filter Replacement” on page 5-27
- “37-mm Filter Cassette Holder Assembly Replacement (Optional)” on page 5-28
- “Bracket Assembly and Power Supply/Charger Replacement” on page 5-30
- “Service Locations” on page 5-32

## General Guidelines

The ADR-1500 is designed to be recalibrated at the factory. However, replacement of the parts listed in [Table 5–1](#) can be done by a proficient technician. Access to the internal components of the optical assembly by others than authorized Thermo Fisher Scientific personnel voids warranty.



**Equipment Damage** Unless a MALFUNCTION message is displayed, or other operational problems occur, the ADR-1500 should be returned to the factory once every year after being placed into service for routine check out, test, cleaning and calibration check. ▲

## Replacement Parts List

Table 5–1 lists the replacement parts for the ADR-1500 major subassemblies. Refer to Figure 5–1 to identify the component location.

**Table 5–1.** ADR-1500 Replacement Parts

Part Number	Description
107942-00	pDR Port Software CD ROM
107418-00	Particulate Inlet Assembly
107495-00	Sealing Plug
107400-00	Bracket Filter Mount
108871-00	Relay Kit
108835-00	Relay
107493-00	Relay Cable Assembly
105140-00	LCD Display Assembly
104052-00	Pump
106909-00	Communications PCB
108773-00	Heater Switch Cable Assembly
04-001576	Heater Switch
107422-00	In-Line Flow Meter Filter (with fittings)
32-000380	In-Line Flow Meter Filter (without fittings)
108960-00	Extended Monitoring HEPA Filter
108834-00	Battery, Lead Acid
108517-00	Bracket Assembly, Power Supply/Charger
108764-00	Power Supply Assembly
108765-00	Power Supply Cable Assembly
108766-00	Charger Assembly
108518-00	Battery Mounting Bracket
107480-00	Battery Cable Assembly
108857-00	External USB Cable Assembly
108810-00	External Analog Cable Assembly
108807-00	External 12/24 VDC Cable Assembly
108888-00	Fuse, 1.5 Amp, Slow Blow, 5 x 20 mm
109148-00	Blue Cyclone Assembly
109149-00	Red Cyclone Assembly
109055-00	Cyclone Adapter Assembly

## Maintenance and Service

<b>Part Number</b>	<b>Description</b>
950-3110	Fiberglass Filter 37-mm 100/Box
109356-00	Stainless Steel Filter Support Screens (pkg of 3)
105854-00	PVC 5.0 $\mu$ m 37-mm Filter 50/Box
AAWP03700	0.8 $\mu$ m 37-mm Filter 100/Box
108824-00	Filter Support and Holder
107418-00	Inlet Assembly
105110-00	Cyclone Adapter Replacement O-ring
109170-00	Blue or Red Cyclone Replacement O-ring Kit
105110-00	Inlet Replacement O-ring
108876-00	Pole Mounting Kit, 2"
108877-00	Pole Mounting Kit, 3"
108878-00	Pole Mounting Kit, 4"
108892-00	Zeroing Filter Assembly
109174-00	37 mm Filter Cassette Holder
108836-00	Instruction Manual

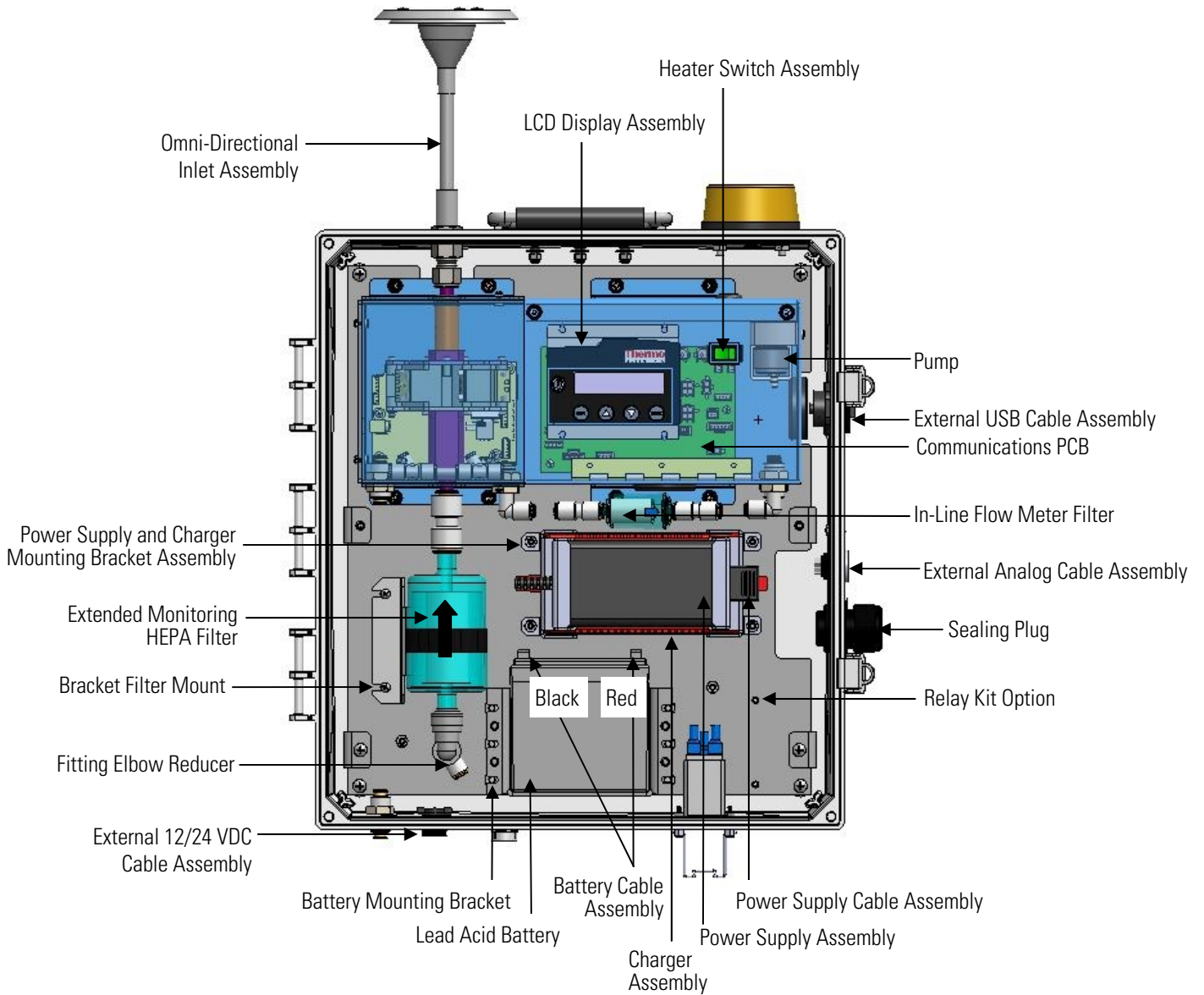

**Figure 5–1.** ADR-1500 Instrument Layout

## Instrument Storage

To store the ADR-1500 for an extended period of time (i.e., one month or more) disconnect the battery cable from J6 or J8 from the power/communications board. This will have no effect on data retention or internal clock function.

During storage always maintain the unit with the inlet covered to protect the sensing optics from gradual dust contamination. Store the ADR-1500 in a dry environment.



**Equipment Damage** Disconnect the battery cable from the power communication board. ▲

## Cleaning of Optical Sensing Chamber

Although the ADR-1500 incorporates an aerodynamic inlet to optimize aerosol delivery through the sensing chamber, continued sampling of airborne particles at high concentrations may result in gradual build-up of contamination on those interior surfaces of the sensing chamber components. This may cause an excessively high optical background level. If this background level does become excessive, the ADR-1500 will alert the user at the completion of the zeroing sequence. If this message is presented, the ADR-1500 can continue to be operated providing accurate measurements only if the background can be reduced. This “might” be possible by blowing a stream of compressed filtered air through the optical chamber and re-zeroing.



**Equipment Damage** If unsuccessful, the instrument must be sent back to the factory for service. ▲

## Removing the Internal Covers

The internal covers can be removed to allow access to the core components of the ADR-1500. Partial removal allows access to the power/com assembly and center panel of the ADR-1500 and full removal allows access to everything on the ADR-1500. Refer to the following steps when a procedure requires partial or full removal of the internal cover (Figure 5–2).



**Equipment Damage** Some internal components can be damaged by small amounts of static electricity. A properly grounded antistatic wrist strap must be worn while handling any internal component. ▲

1. Turn the instrument OFF. Remove the AC plug from the bottom of the instrument.
2. For access to the power/com assembly, unfasten the two captive hardware and swing cover down. For center panel removal, unfasten the two captive hardware and swing cover down. For full removal, unfasten the two captive hardware and six screws.
3. Disconnect the battery cable from J6 or J8 from the power communication board.
4. Re-install the internal cover by following the previous steps in reverse order.



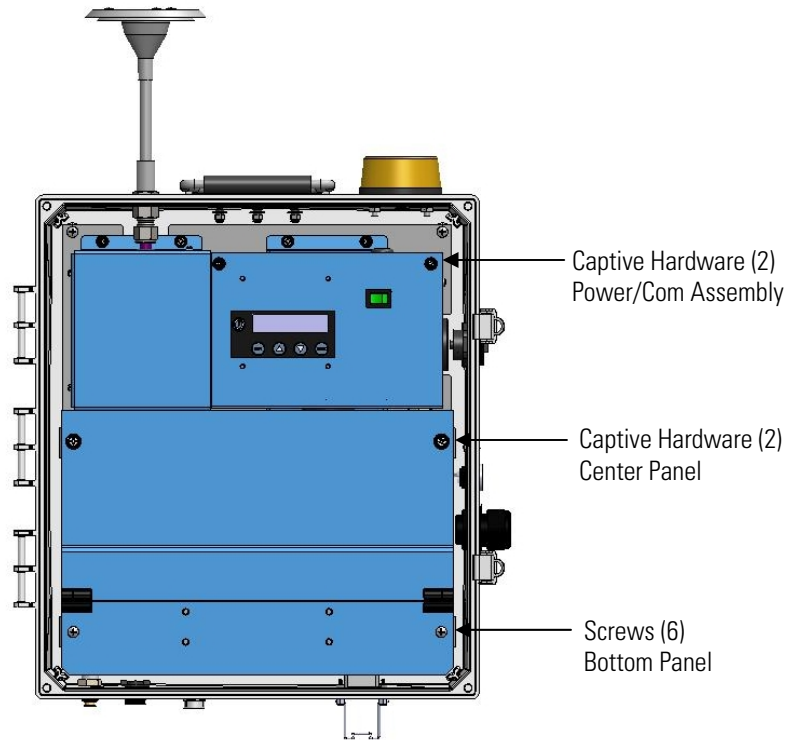

**Figure 5–2.** Removing the Internal Cover

## LCD Assembly Replacement

Use the following procedure to replace the LCD assembly (Figure 5–3).

1. Turn the instrument OFF. Remove the AC plug from the bottom of the instrument.
2. Unfasten the two captive hardware and swing cover down on the power/com assembly.
3. Disconnect the battery cable from J6 or J8 from the power communication board.
4. Unplug the ribbon cable from the LCD board.
5. Unfasten the four nuts at the corners of the LCD board.
6. Lift the LED screen out of the housing.
7. Remove the four nuts from the LCD.
8. Re-install the four nuts into the new LCD, and replace the LCD by following the previous steps in reverse order.



**CAUTION** Disconnect battery power and external power supplies before servicing. ▲



**Equipment Damage** Some internal components can be damaged by small amounts of static electricity. A properly grounded antistatic wrist strap must be worn while handling any internal component. ▲

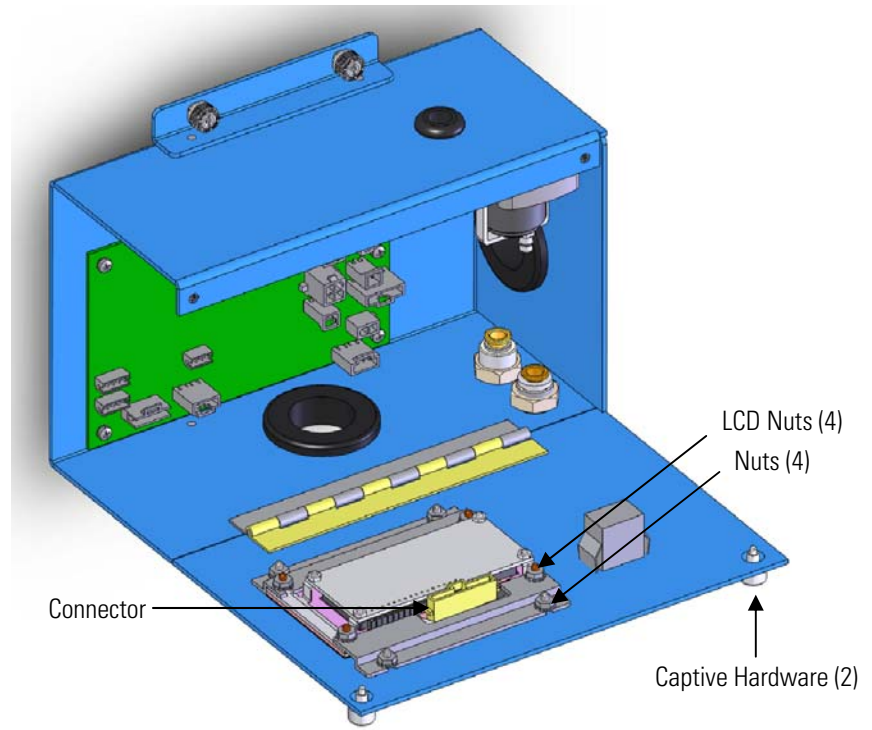

**Figure 5–3.** Replacing the LCD Assembly

## Pump Assembly Replacement

Use the following procedure to replace the pump (Figure 5–4).

1. Turn the instrument OFF. Remove the AC plug from the bottom of the instrument.
2. Unfasten the two captive hardware and swing cover down on the power/com assembly.
3. Disconnect the battery cable from J6 or J8 from the power communication board.
4. Disconnect the connector from the board “PUMP IN”.
5. Take needle nose pliers and push down on fitting to release tubing (vacuum port).
6. Take needle nose pliers and push down on fitting to release tubing (pressure port).
7. Pull pump out from clip.
8. Remove tubing from pump and install onto new pump.
9. Make sure to find the “arrow” under the pump fitting. This is your **vacuum port**. Install pump back onto clip.
10. Install the vacuum port tube “arrow from pump fitting” to the straight fitting of the housing.
11. Install pressure tube to the elbow fitting on the housing.
12. Reconnect pump connector to “PUMP IN” to the board.
13. Install the new pump by following the previous steps in reverse order.



**CAUTION** Disconnect battery power and external power supplies before servicing. ▲



**Equipment Damage** Some internal components can be damaged by small amounts of static electricity. A properly grounded antistatic wrist strap must be worn while handling any internal component. ▲

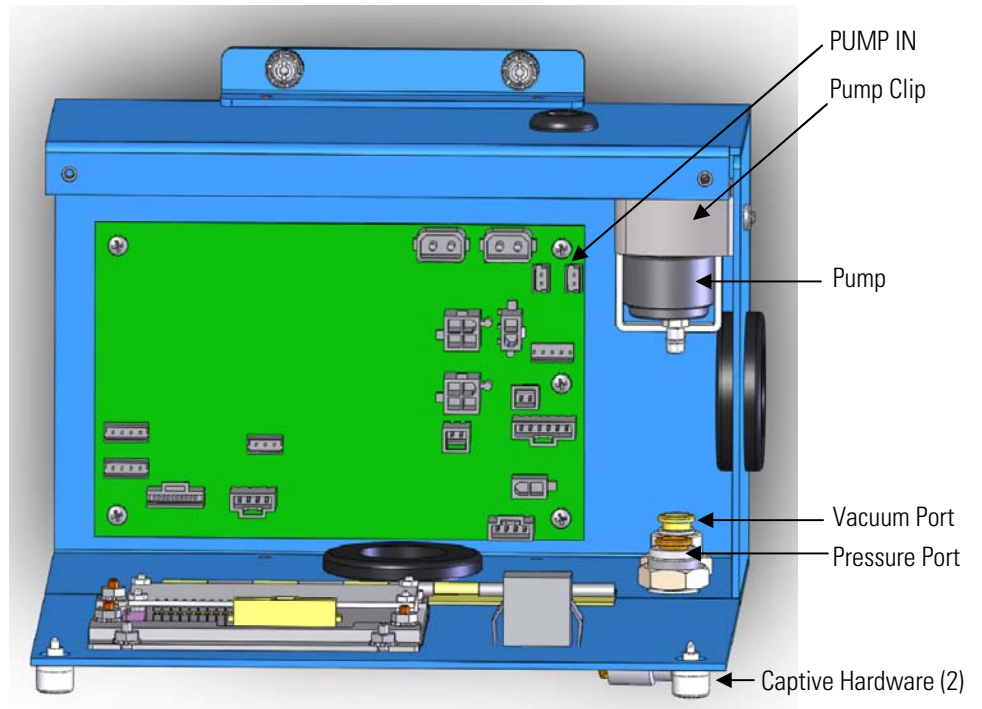

**Figure 5–4.** Replacing the Pump

## Communications PCB Replacement

Use the following procedure to replace the communications printed circuit board (Figure 5-5).

1. Turn the instrument OFF. Remove the AC plug from the bottom of the instrument.
2. Unfasten the two captive hardware and swing cover down on the power/com assembly.
3. Disconnect the battery cable from J6 or J8 from the power communication board.
4. Unplug all connectors from the communications PCB. Note the locations of the connectors to facilitate re-connection. See Figure 5-7).
5. Unscrew the five screws from the communications PCB and remove the board.
6. Install the new communications PCB following the previous steps in reverse order.



**CAUTION** Disconnect battery power and external power supplies before servicing. ▲



**Equipment Damage** Some internal components can be damaged by small amounts of static electricity. A properly grounded antistatic wrist strap must be worn while handling any internal component. ▲

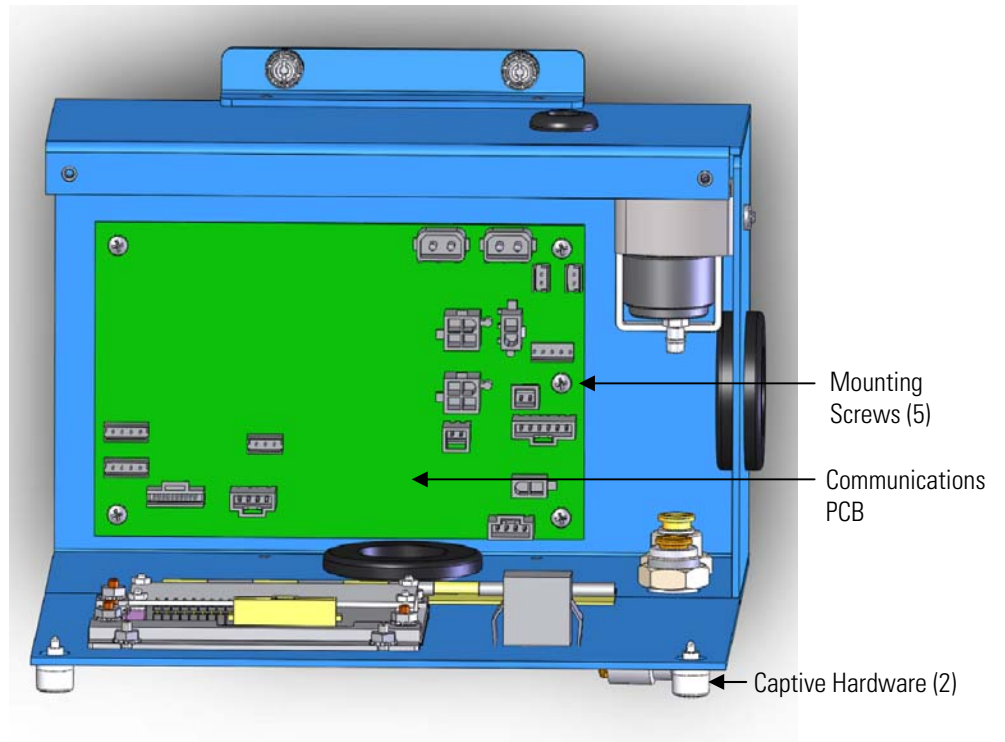

**Figure 5-5.** Replacing the Communications PCB

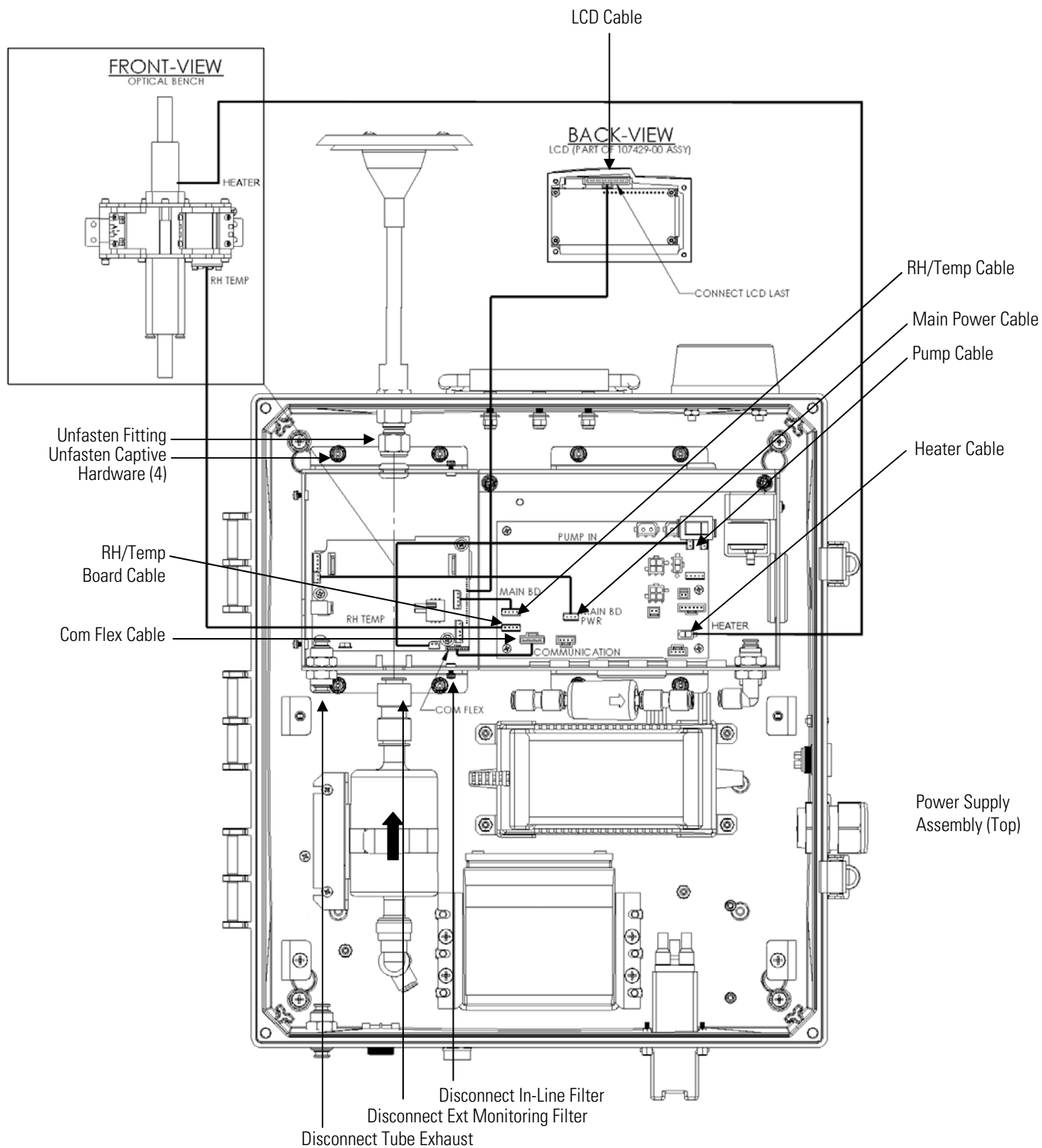

Figure 5-6. Wiring Diagram 1



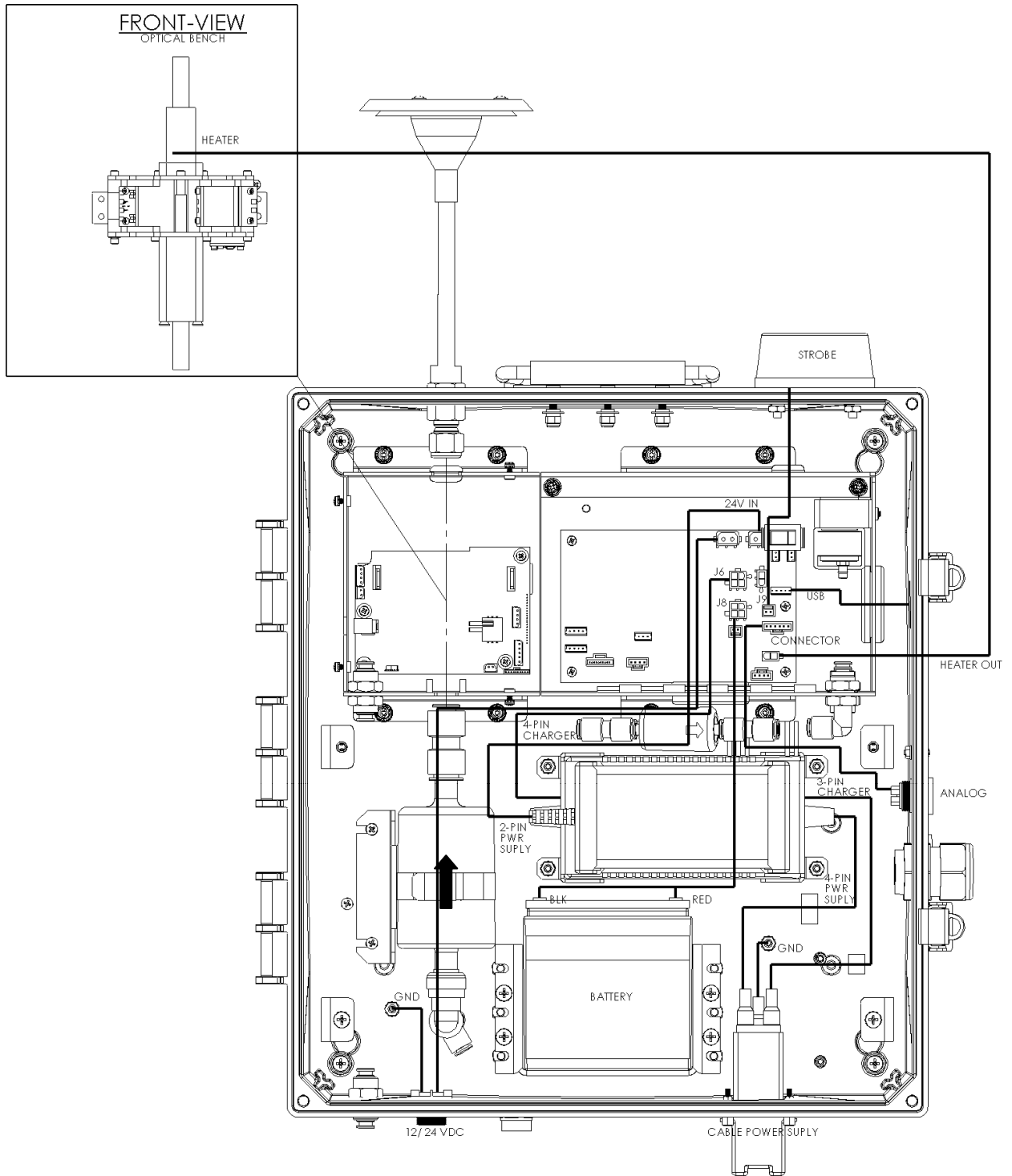

Figure 5-7. Wiring Diagram 2

## Optics Enclosure Assembly Removal

Use the following procedure to remove the optics enclosure assembly.

1. Turn the instrument OFF. Remove the AC plug from the bottom of the instrument.
2. Unfasten the two captive hardware and swing cover down on the power/com assembly.
3. Disconnect the battery cable from J6 or J8 from the power communication board.
4. Disconnect "LCD cable" from LCD.
5. Disconnect "Main board power cable" from communication board "J13".
6. Disconnect "RH/Temp Cable" from communication board "Main BD J12"
7. Disconnect "RH/Temp BD cable" from communication board "J14".
8. Disconnect "Com flex cable" from communication board "J16".
9. Disconnect "pump cable" from communication board "PUMP IN J3".
10. Disconnect "heater cable" form communication board "HEATER OUT J15".
11. Use needle nose pliers and release the push connect fitting that is attached to the tubing on the small bypass filter.
12. Use needle nose pliers and release the push connect fitting that is attached to the large bypass filter. Move filter downwards to gain space.
13. Use needle nose pliers to release exhaust port tubing.
14. Use adjustable wrench to loosen inlet fitting.

15. Unfasten the four captive hardware, and slide whole enclosure assembly downwards and out.
16. Send the entire optic enclosure assembly to Thermo Fisher Scientific for repair or maintenance.
17. To facilitate reconnection, repeat steps 4 to 13 in reverse order and refer to [Figure 5–6](#).



**Equipment Damage** Some internal components can be damaged by small amounts of static electricity. A properly grounded antistatic wrist strap must be worn while handling any internal component. ▲

## Heater Switch Assembly Replacement

Use the following procedure to replace the heater switch assembly (Figure 5–8).

1. Turn the instrument OFF. Remove the AC plug from the bottom of the instrument.
2. Unfasten the two captive hardware and swing cover down on the power/com assembly.
3. Disconnect the battery cable from J6 or J8 from the power communication board.
4. Unplug the connector from board “HEATER SW”.
5. Use needle nose pliers and squeeze the sides and push switch out of cover.
6. Snap the new replacement switch into cover housing (see Figure 5–9). Make sure the 1 is facing left and the 0 is facing right. Refer to the “ISO” view in Figure 5–9.
7. Connect wire harness “lug end” to the top 2 or bottom 2, but **not one of each**. Connect red wire to gold terminal and black wire to silver terminal.
8. Connect the other end of the wire harness to “HEATER SW” J17 on the board.
9. Replug the power by following steps 1 to 3 in reverse order.

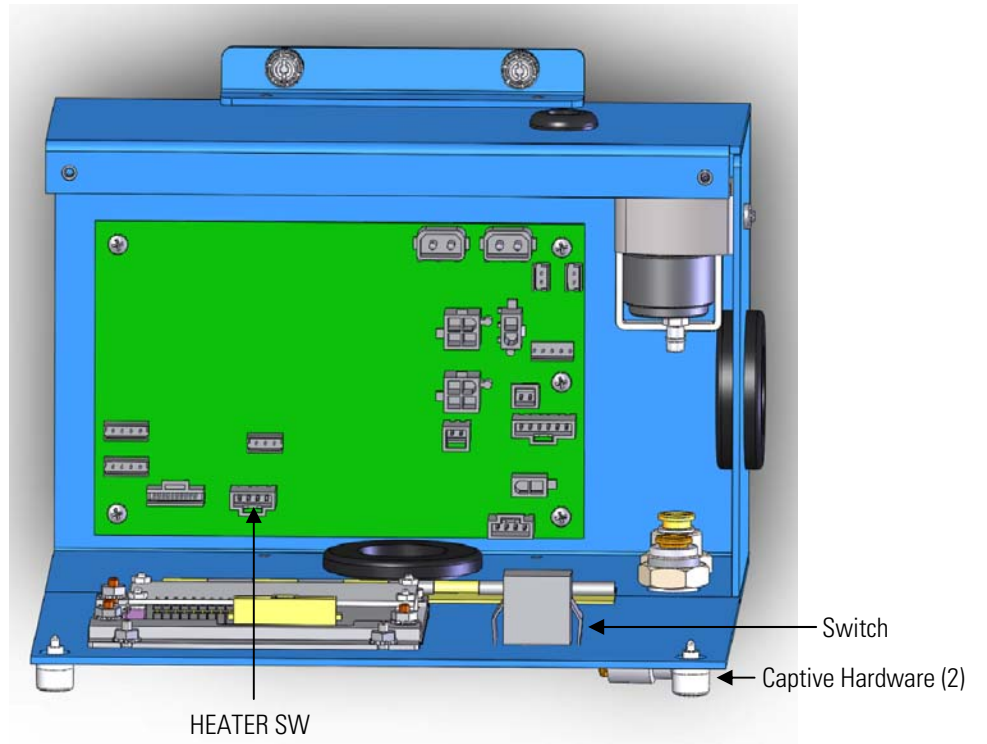

**Figure 5–8.** Replacing the Heater Switch Assembly

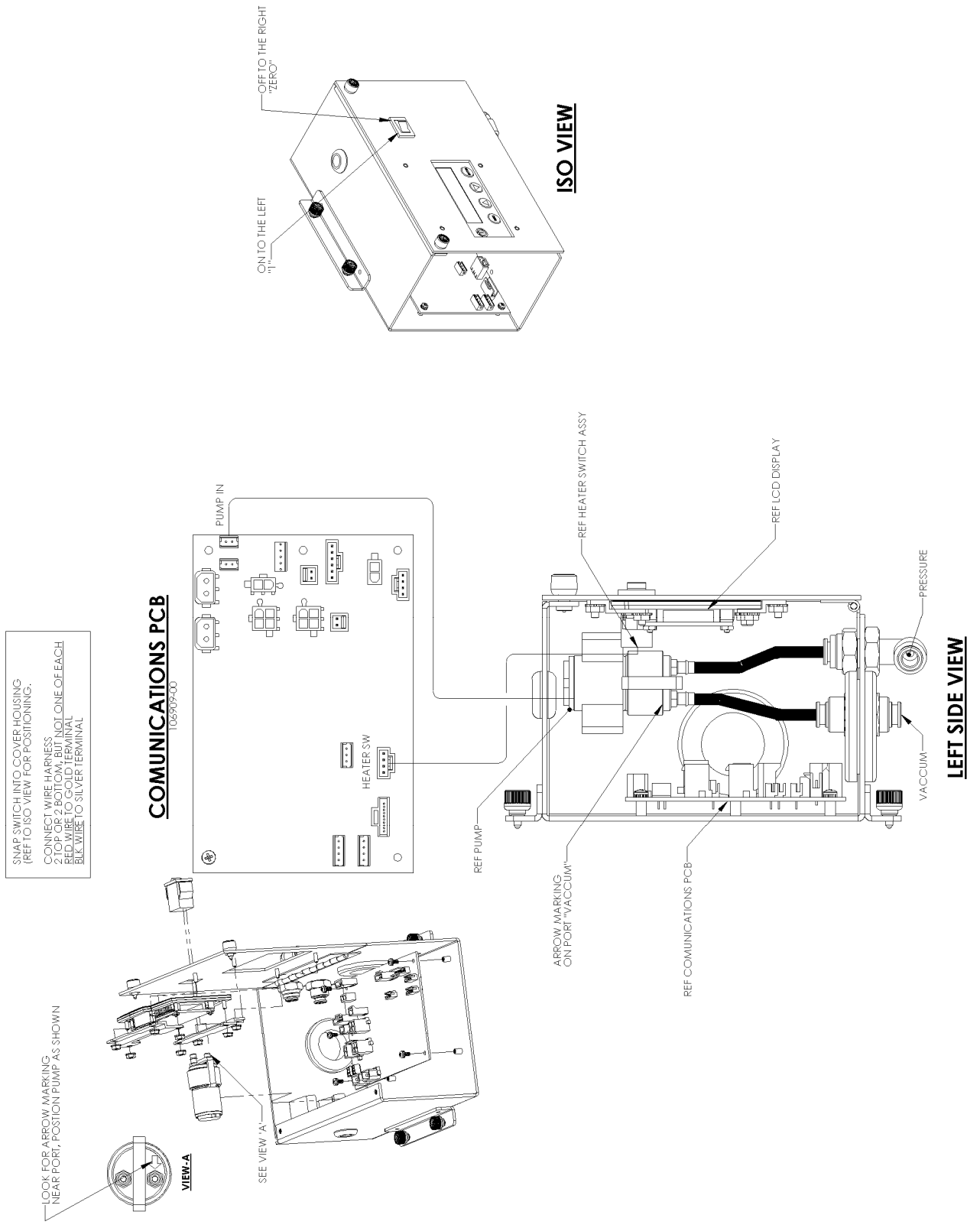

**Figure 5-9. Power/Com Assembly-Pump Installation**

## Battery Use

The ADR-1500 power supply can be connected continuously to the instrument whether the ADR-1500 is on or off. However, the 12-24 VDC external power supply **will not** charge the battery inside the ADR-1500.



**Equipment Damage** The instrument should be charged in the upright position. ▲



**Equipment Damage** Replace with specified battery only. ▲

## Lead Acid Battery Replacement

Use the following procedure to replace the lead acid battery (Figure 5–10).

1. Turn the instrument OFF. Remove the AC plug from the bottom of the instrument.
2. Unfasten the two captive hardware and six screws to fully remove the cover.
3. Disconnect the battery cable from J6 or J8 from the power communication board.
4. Remove the battery cover plate and slide out the old battery.
5. Insert new battery, and follow previous steps in reverse order.



**CAUTION** Disconnect battery power and external power supplies before servicing. ▲



**Equipment Damage** Some internal components can be damaged by small amounts of static electricity. A properly grounded antistatic wrist strap must be worn while handling any internal component. ▲



**Equipment Damage** Replace with specified battery only. ▲



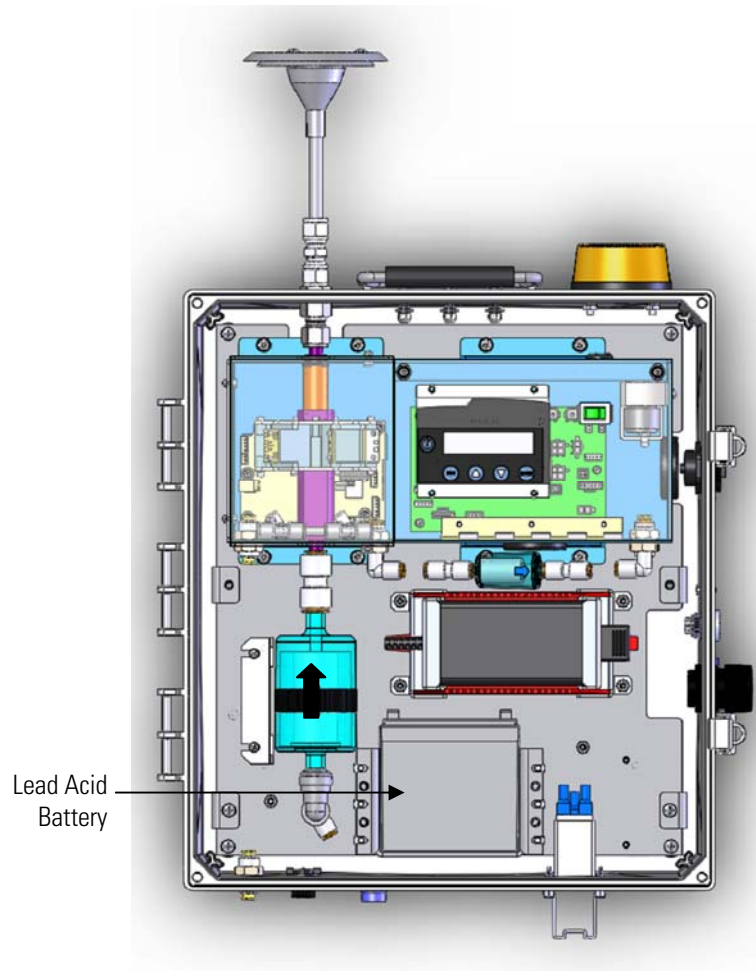

**Figure 5–10.** Replacing the Lead Acid Battery

## In-Line Flow Meter Filter with Fittings Replacement

Use the following procedure to replace the in-line flow meter filter with fittings (Figure 5–11).

1. Turn the instrument OFF. Remove the AC plug from the bottom of the instrument.
2. Unfasten the two captive hardware and swing cover down on the center panel.
3. Disconnect the battery cable from J6 or J8 from the power communication board.
4. Use needle nose pliers and release the fitting from the tubing.
5. To install the new filter, follow the previous steps in reverse order.

**Note** When replacing the new filter make sure filter arrow is facing towards the right. ▲

## Extended Monitoring HEPA Filter Replacement

Use the following procedure to replace the extended monitoring HEPA filter (Figure 5–11).

1. Turn the instrument OFF. Remove the AC plug from the bottom of the instrument.
2. Unfasten the two captive hardware and swing cover down on the center panel.
3. Disconnect the battery cable from J6 or J8 from the power communication board.
4. Use needle nose pliers and release the filter stem from the fittings.
5. To install the new filter, follow the previous steps in reverse order.

**Note** When replacing the new filter make sure filter arrow is facing up. ▲

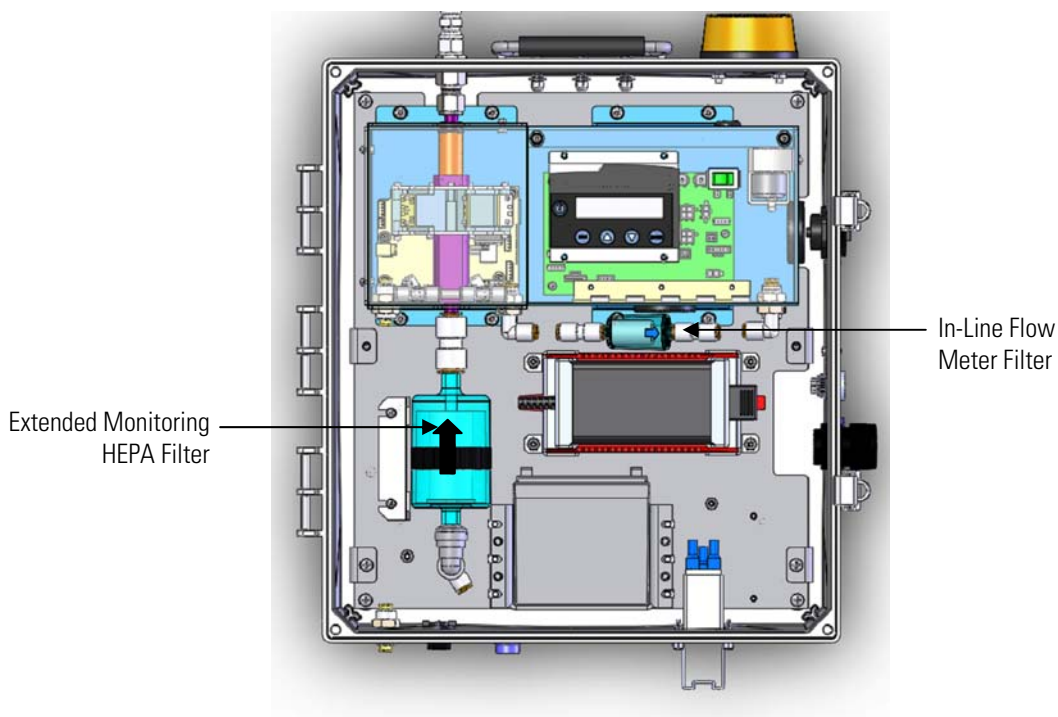
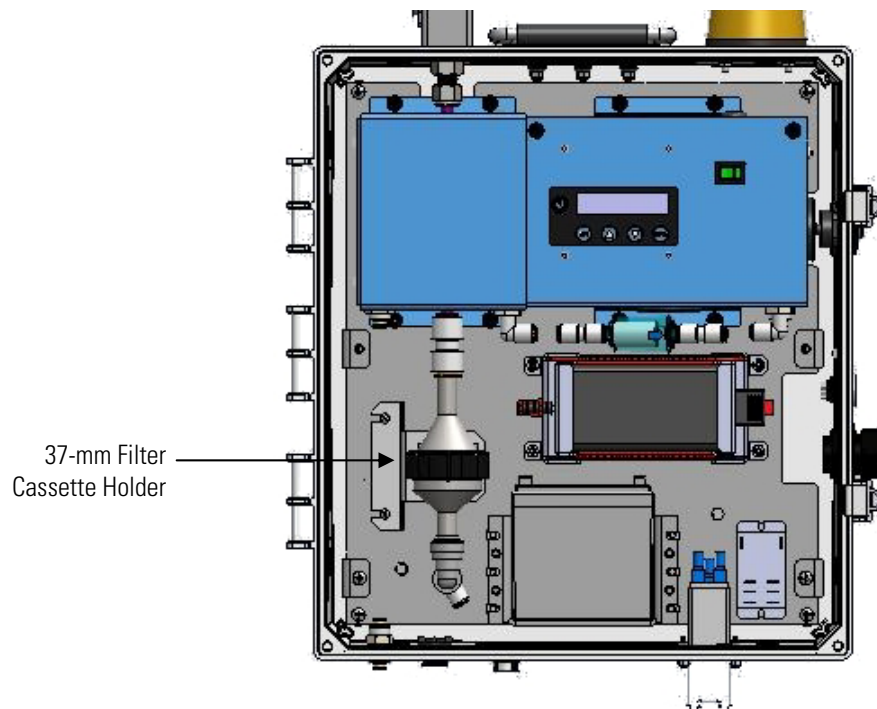

**Figure 5–11.** Replacing the Filters

## 37-mm Filter Cassette Holder Assembly Replacement (Optional)

Use the following procedure to replace the optional 37-mm filter cassette holder assembly (Figure 5–12).

1. Turn the instrument OFF. Remove the AC plug from the bottom of the instrument.
2. Unfasten the two captive hardware and swing cover down on the center panel.
3. Disconnect the battery cable from J6 or J8 from the power communication board.
4. Remove the filter by depressing the overlapping push connect fitting to release the HEPA filter.
5. To install the new filter, follow the previous steps in reverse order.



**Figure 5–12.** Replacing the 37-mm Filter Cassette Holder Assembly

The 37-mm filter holder should have a fresh glass fibre filter installed prior to each day of monitoring in order to keep the pump protected. Operation without this filter in place, or without the filter changed as prescribed, will void the warranty. Turn the compression ring clockwise to seal the cassette into the holder. Turn the compression ring counter-clockwise to disassemble.

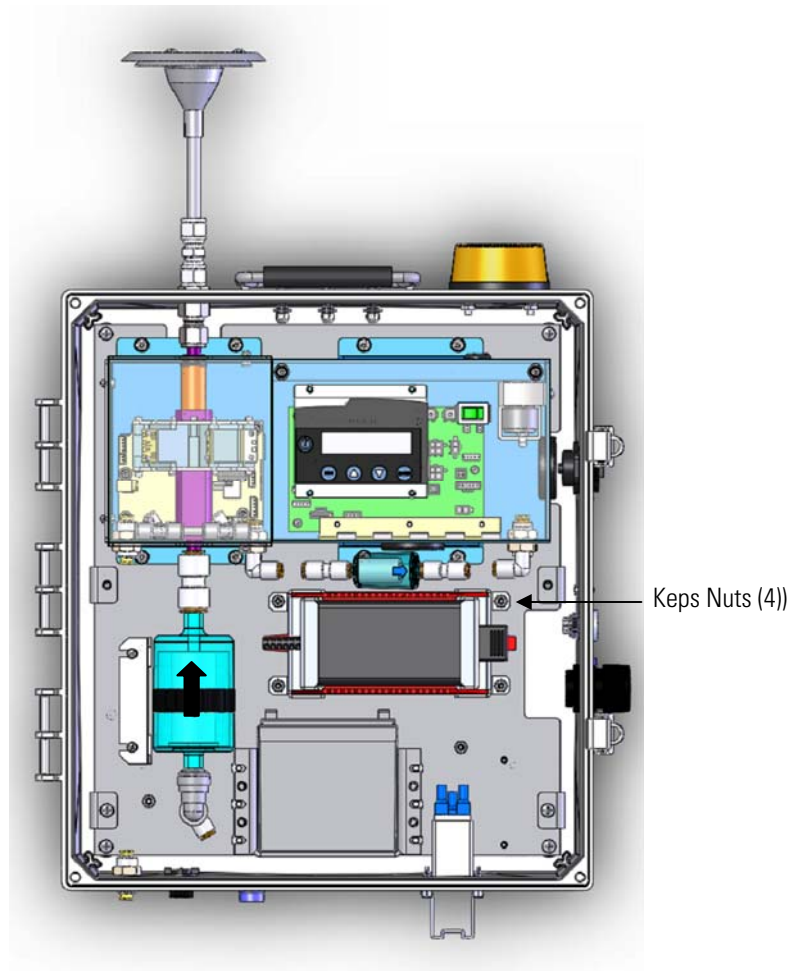

**Figure 5–13.** Filter Support and Holder – Snap Rings and Filter

## Bracket Assembly and Power Supply/Charger Replacement

Use the following procedure to replace the bracket assembly and power supply/charger (Figure 5–14).

1. Turn the instrument OFF. Remove the AC plug from the bottom of the instrument.
2. Unfasten the two captive hardware and swing cover down from the power/com assembly and on the center panel.
3. Disconnect the battery cable from J6 or J8 from the power communication board.
4. Disconnect connectors from board and cable power supply. Note the locations of the connectors to facilitate re-connection. See Figure 5–7.
  - a. Power supply disconnect:
    - 4-pin power supply to cable power supply
    - 2-pin to 24 V J1 on the power communication board
  - b. Charger disconnect:
    - 3-pin charger to cable power supply
    - 4-pin charger to J6 or J8 to power communication board
5. Unfasten four keps nut and remove brackets.
6. Replace bracket assembly and power supply charger following the previous steps in reverse order.



**Figure 5–14.** Replacing the Bracket Assembly and Power Supply/Charger

## **Service Locations**

Service is available from exclusive distributors worldwide. Contact one of the phone numbers below for product support and technical information or visit us on the web at [www.thermo.com/aqi](http://www.thermo.com/aqi).

1-866-282-0430 Toll Free

1-508-520-0430 International



# Chapter 6

## Troubleshooting

This instrument has been designed to achieve a high level of reliability. In the event of problems or failure, the troubleshooting guidelines, board-level connection diagram, presented in this chapter should be helpful in isolating and identifying problems.

The Technical Support Department at Thermo Fisher Scientific can also be consulted in the event of problems. See “[Service Locations](#)” at the end of this chapter for contact information. In any correspondence with the factory, please note both the serial number and program number of the instrument.

This chapter provides the following troubleshooting and service support information:

- “[Safety Precautions](#)” on page 6-2
- “[Troubleshooting Guide](#)” on page 6-3
- “[Instrument Status Flags](#)” on page 6-5
- “[Board-Level Block Diagram](#)” on page 6-6
- “[Connector Pin Descriptions](#)” on page 6-7
- “[Service Locations](#)” on page 6-10

## **Safety Precautions**

Read the safety precautions in the Preface and “[Maintenance and Service](#)” chapter before performing any actions listed in this chapter.

# Troubleshooting Guide

The troubleshooting guide presented in this chapter is designed to help isolate and identify instrument problems.

Table 6–1 provides general troubleshooting information and indicates the checks that you should perform if you experience an instrument problem.

Table 6–2 lists the error code responses from zeroing.

**Table 6–1.** Troubleshooting – General Guide

Malfunction	Possible Cause	Action
No power	Main fuses are blown or missing	Check voltages from power supply.
	Digital electronics defective	Check that all boards and connectors are seated properly. Replace with spare boards to isolate the problem.
	Disconnected cable	Verify cable connections.
	Defective power supply	Replace power supply.
Display is off	Wrong contrast setting	Adjust contrast setting.
	LCD cable loose	Check connection and cable integrity.
	LCD defective	Replace display.
No flow	Blocked inlet	Verify inlet is not blocked.
	Disconnected pump cable	Verify cable connection.
	Disconnected tube	Verify tubing connection.
	Clogged HEPA filter	Replace filter.
	Defective pump	Replace pump.
No battery power	Disconnected battery cable	Connect battery cable.
	Battery not charged	Charge battery.
Battery will not take a charge	Disconnected cable	Verify cable connections.
	Battery defective	Replace battery.
	Charger defective	Replace charger.
No RH/Temp Readings	Disconnected cable	Verify cables.
	RH/Temp board defective	Send in for service.
No USB communication	Wrong COM port (pDR Port)	Verify COM port (pDR Port).
	Disconnected cable	Verify cable.

## Troubleshooting

<b>Malfunction</b>	<b>Possible Cause</b>	<b>Action</b>
	Defective external USB cable	Replace cable.
	Defective internal USB cable	Send in for service.
Non-working strobe	Disconnected cable	Verify cable connection.
	Defective strobe	Send in for service.
No relay (if installed)	Disconnected cable	Verify cable connection.
	Defective relay	Replace relay.

## Instrument Status Flags

During zeroing, the ADR-1500 also performs diagnostics on the optics and flow rates. The only allowable fault is “Background High”. All other faults will result in a failure to zero the instrument. All faults are reported with a hex coded error flags. The faults can be determined from the following table, but if a fault persists, the ADR-1500 instrument requires service.

**Table 6–2.** Troubleshooting – Error Code Responses from Zeroing

Hex code [Flags]	Binary	Fault	Fault criteria
02 x	0000 0010 b	Background High	> 1000 µg/m <sup>3</sup>
03 x	0000 0011 b	Background calculation FAILED	Detector signal is not sensed or it is not properly amplified.
04 x	0000 0100 b	Source current low	< 50 mA
08 x	0000 1000 b	Source current high	> 75 mA
10 x	0001 0000 b	Ref. detector low	< 75% Factory set
20 x	0010 0000 b	Ref. detector high	> 125% Factory set
40 x	0100 0000 b	Pump low	< 90%
80 x	1000 0000 b	Pump high	> 110%

## Board-Level Block Diagram

Figure 6–1 is a board-level block diagram for the ADR-1500 and can be used to troubleshoot board-level faults. This illustration can be used along with the connector pin description in Table 6–3 to troubleshoot board-level faults.

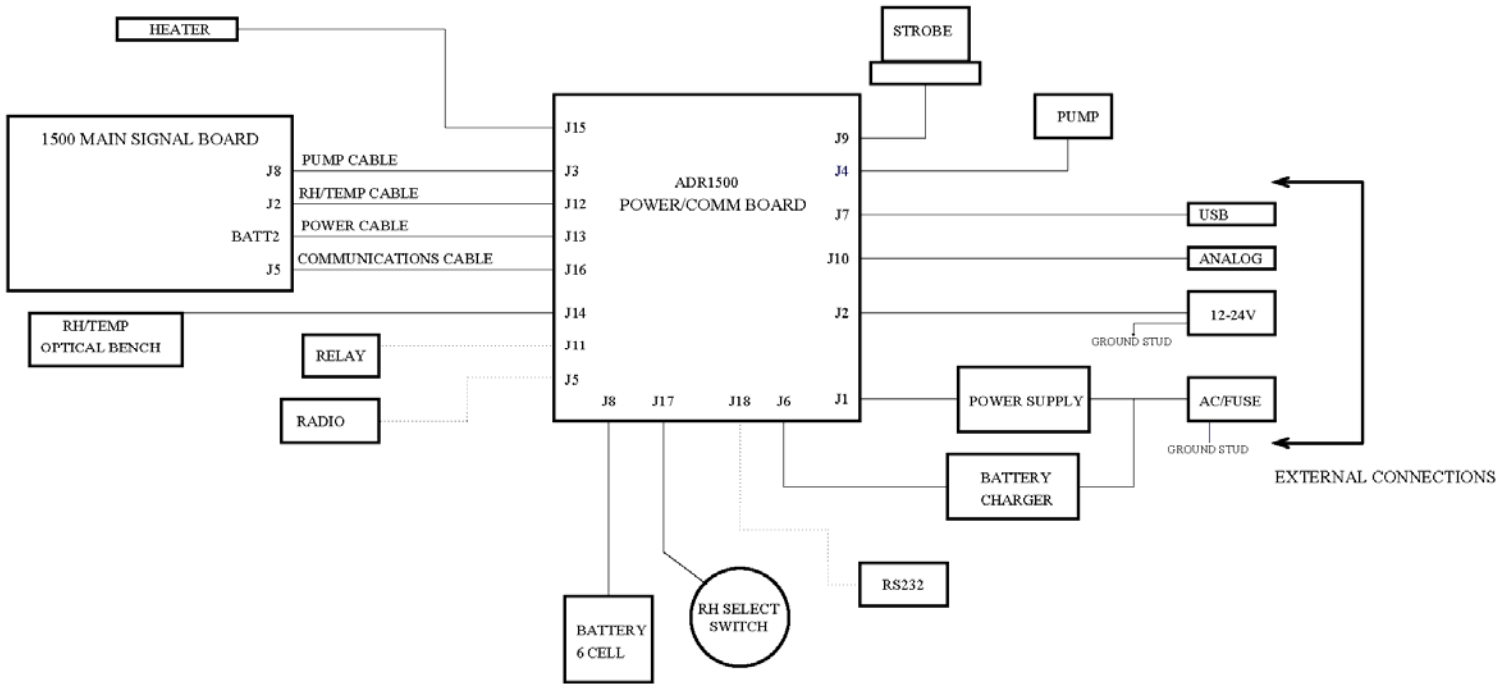

**Figure 6–1.** ADR-1500 Board-Level Block Diagram

## Connector Pin Descriptions

The connector pin description in [Table 6–3](#) can be used along with the board-level connection diagram to troubleshoot board-level faults.

**Table 6–3.** ADR-1500 Communications Board Pin Out

Connector Label	Reference Designator	Pin	Signal Description
24 VDC	J1	1	DC+
		2	Power Ground
Eternal 12/24 VDC	J2	1	DC+
		2	Power Ground
Pump In 0-8 VDC Depending on flow rate	J3	1	DC+
		2	Power Ground (From Main Signal Board)
Pump Out 0-8 VDC Depending on flow rate	J4	1	DC+
		2	Power Ground (From Main Signal Board)
Auxiliary/Radio 12VDC	J5	1	DC+
		2	Power Ground
Lead Acid Battery or Charger VDC	J6	1	No Connection
		2	DC+
		3	No Connection
		4	Power Ground
USB	J7	1	USB_VBUS
		2	USB_D-
		3	USB_D+
		4	Ground
		5	Ground Chassis
Lead Acid Battery or Charger VDC	J8	1	No Connection
		2	DC+
		3	No Connection
		4	Power Ground

## Troubleshooting

Connector Label	Reference Designator	Pin	Signal Description
Strobe/Relay 12VDC	J9	1	DC+
		2	Power Ground
Analog Out	J10	1	Voltage_OUT
		2	Current_OUT
		3	Power Ground
		4	Alarm
		5	Power Ground
		6	Ground Chassis
Strobe/Relay 12VDC	J11	1	DC+
		2	Power Ground
RH/Temp to Main Signal Board	J12	1	Ground
		2	No Connection
		3	Temp
		4	RH
		5	No Connection
Power for main Signal Board	J13	1	Battery Voltage 1/6
		2	Power Ground
		3	8+ VDC
RH/Temp Board	J14	1	Ground_Analog
		2	5+ VDC
		3	Temp
		4	RH
Heater	J15	1	DC+
		2	Power Ground
Communication from Main Signal Board	J16	1	USB_VBUS
		2	USB_D-
		3	USB_D+
		4	Ground
		5	Ground
		6	RS232_RXD
		7	RS232_TXD
		8	Voltage_OUT



Connector Label	Reference Designator	Pin	Signal Description
		9	Current_OUT
		10	Alarm
Heater Switch	J17	1	5+ VDC
		2	Enable
		3	No Connection
RS232	J18	1	RS232_RXD
		2	RS232_TXD
		3	Ground
		4	Ground Chassis

## **Service Locations**

Service is available from exclusive distributors worldwide. Contact one of the phone numbers below for product support and technical information or visit us on the web at [www.thermo.com/aqi](http://www.thermo.com/aqi).

1-866-282-0430 Toll Free

1-508-520-0430 International

# Chapter 7

## Outputs and Alarm

This chapter describes serial communications and analog/alarm output.

- “Analog Signal Output” on page 7-2
- “Alarm Description and Operation” on page 7-3
- “Analog Outputs” on page 7-4
- “Real-time RS-232 Output” on page 7-6
- “Serial Communications Protocols” on page 7-7

## Analog Signal Output

The ADR-1500 incorporates the capability to provide both a voltage and a current signal output directly proportional to the sensed concentration of airborne particulates. Both these analog signal outputs are concurrently available. These outputs are provided, principally, for fixed-point applications with hard-wired installations.

The particulate concentration range corresponding to the output voltage and current ranges (0 to 2 V and 4 to 20 mA) can be user selected on the ADR-1500 screen (see “[Configuration Review](#)” on page 3-29) or via a PC using the pDR Port communications software package included with the instrument. The most sensitive range available is 0 to 0.01 mg/m<sup>3</sup> (0 to 10.0 µg/m<sup>3</sup>), and the least sensitive range is 0 to 400 mg/m<sup>3</sup>. For example, if the user selects the analog output range of 0 to 0.400 mg/m<sup>3</sup> then the analog output signal levels, at a concentration of 0.200 mg/m<sup>3</sup>, would be 1.0 V and 12 mA. This Analog Output concentration range is independent of the ranging used for the digital display, data logging and real-time digital output range which are controlled automatically (auto ranging).

Since both voltage and current outputs are present at the same time, both can be used concurrently, if so required. The accuracy of the analog output signals is better than 1% of the reading with respect to the digital reading.

The 4 to 20 mA current output is available between pins # 1 and 5 of the 6-pin ANALOG OUTPUTS connector on the side panel (see [Figure 2-7](#)). The 0 to 2 V analog voltage output is available between pins # 1 and 4 of that connector. Pin # 1 is common ground.



**Equipment Damage** For the 0 to 2 V output signal, the externally connected load must have an impedance of more than 200 kilo-ohms; For the 4 to 20 mA output signal, the externally connected load must have an impedance of less than 300 ohms. ▲

## Alarm Description and Operation

In addition to an audible alarm, there is a single alarm switched FET that will enable the yellow beacon on top of the ADR-1500 case. Normally, the switched alarm output is OPEN with respect to ground. During an alarm condition, this output is switched to ground ( $R_{out} < 0.1 \Omega$ ). Whenever the alarm is triggered, the on-board sound will be activated. The alarm function can be enabled or disabled and the alarm level (trigger threshold) can be selected by the user through the ADR-1500 keyboard. The alarm is triggered whenever the selected alarm level is exceeded.

In addition to the audible and beacon alarms, an optional two-pole 30A alarm relay is provided for external process control (e.g., vent/fan switching). This relay assembly can be accessed through the side liquid tight cord gland and provides normally open and normally closed contacts.

When the displayed concentration falls below that level the alarm condition stops. While the alarm is on, the user can disable it momentarily by pressing any key on the ADR-1500. If the concentration continues to exceed the set alarm level after 10 seconds, the alarm condition will be reactivated.

## Analog Outputs

The voltage alarm signal is available between pins # 1 through 5 on the ANALOG OUTPUTS connector in the upper middle of the side panel. In Figure 7-1 below, the alarm driver circuit is depicted.

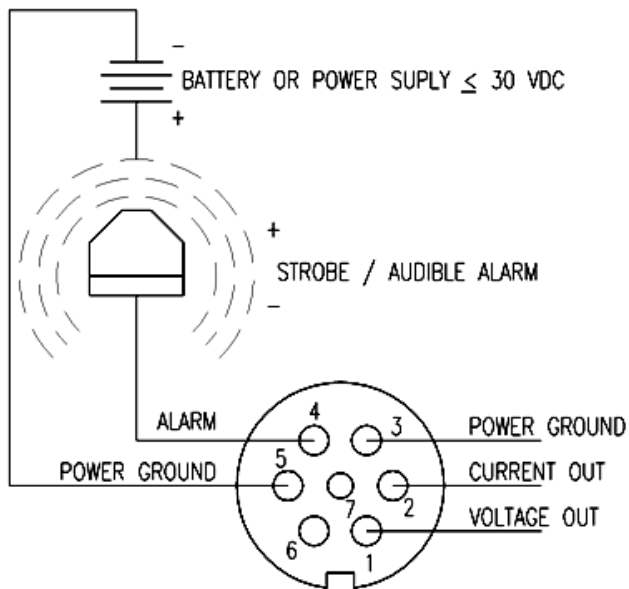

**Figure 7-1.** ADR-1500 External Analog Driver

**Table 7-1.** Analog Output Descriptions

Analog Out	Description	Wire
Pin 1	Voltage_OUT	RED
Pin 2	Current_OUT	BLUE
Pin 3	Power Ground	BLACK
Pin 4	Alarm	ORANGE
Pin 5	Power Ground	GREEN



**WARNING** Do not apply AC voltage to this connector. Maximum allowable DC voltage is 30 V. ▲

The switched alarm output is used to close the circuit of a DC powered device and its power supply at the negative side. For example:

1. The negative terminal of a battery or common ground of a power supply is connected to Pin #5, pDR-1500 ground.
2. The load's (device's) return or negative is connected to #4 (switch alarm output).
3. The positive of the load and battery, or power supply, are connected together.

The minimum external load impedance for this output is 10 kilo-ohms.

## Real-time RS-232 Output

During the RUN mode the ADR-1500 can communicate real-time concentration data through its serial ports via the pDR Port software package. This software application decodes the data and displays the real-time and TWA values in a terminal window.

In order to use this output with some other application, the following information will enable the user to decipher the encoded output signal. The communication settings for the digital output of the ADR-1500 are:

- Baud rate: 19,200
- Data bits: 8
- Stop bits: 1
- Parity: none
- Flow control: none



## Serial Communications Protocols and Use of Modems

The ADR-1500 has two serial ports: RS-232 or USB. Only one can be active at a time and the USB is a slave to the RS-232. The active port is selected via the PC, depending on the connection chosen.

The use of the USB is the primary connection for communicating with the ADR-1500 via pDR Port user interface software.

The use of the RS-232 connector has been reserved for after-market applications if modem connectivity (e.g., wireless modem) through which a continuous stream of concentration data can be transmitted. For more information on connecting to the RS-232 port, refer to Appendix B “[Serial Commands](#)”

The communications commands recognized are listed in Appendix B. Mostly these pertain to setup variables in the ADR-1500. The response format will generally repeat the address and command and then follow with the ADR-1500's current settings.



## Chapter 8

# Optional Accessories

The ADR-1500 is available with the following options:

- “37-mm Filter Cassette Holder Assembly” on page 8-2
- “Relay Kit” on page 8-3
- “Inlets” on page 8-5
- “Cables” on page 8-6
- “Pole Mounting Kits” on page 8-7

## **37-mm Filter Cassette Holder Assembly**

The 37-mm filter cassette holder assembly is used for sample collection, during a run, for the purpose of post-sampling gravimetric analysis, chemical speciation and microscopy.

For more information on the 37-mm filter cassette holder and replacing, see “[37-mm Filter Cassette Holder Assembly Replacement \(Optional\)](#)” on page 5-28.

## Relay Kit

The relay kit permits the user to activate external alarm indicators. The ADR-1500 provides a switched alarm output, triggered by the alarm signal of the monitor. This switched output (up to 30 amperes, 250 volts) can be used to control other equipment and/or to activate other external alarm indicators. This switched alarm output operates in conjunction with the flashing alarm beacon on the outside of the ADR-1500 enclosure.

## Alarm Relay Connection

To connect this switched alarm signal to any external equipment, the alarm terminal strip on the lower right of the interior of the ADR-1500 must be accessed. To do so, open the front door, and remove the access panel. Utilize the figure below (Figure 8–1) to identify the corresponding switch configuration.

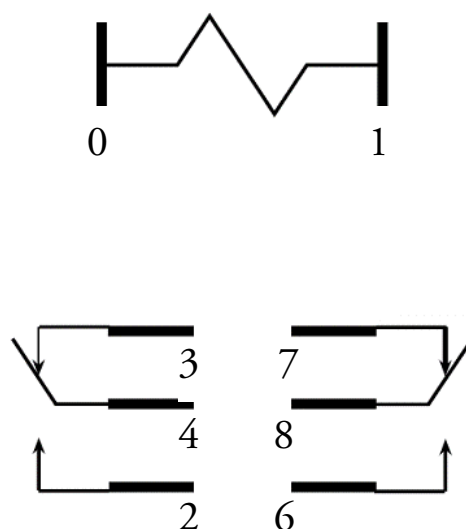

**Figure 8–1.** Alarm Relay Connection

- Terminals #2 and #4 are a normally open switch
- Terminals #6 and #8 are a normally open switch
- Terminals #3 and #4 are a normally closed switch
- Terminals #7 and #8 are a normally closed switch

**Note** Only necessary terminals are present on single throw models. ▲

Each of the above two switches can switch loads of up to 30 amperes.

Once the leads have been connected to the appropriate terminals of the alarm relay, the sheet metal cover should be reinstalled and secured. The leads should be passed through the adjacent free feed-through cable ground and connected as a switch to apply power to the required external equipment to be controlled by the alarm condition. For DC power application, connect the wire from terminal #1 to the negative terminal of the power source (i.e., battery or D.C. supply). Finally, plug in the cyclone making sure to insert it completely.

## Inlets

A variety of inlets are offered to target a specific aerosol size:

- Red Cyclone – provides an ACGIH traceable D50 AED cut point ranging from 3 to 12 micrometers
- Blue Cyclone – provides an ACGIH traceable D50 AED cut point ranging from 1 to 4 micrometers

For more information on inlets, see “[Particle Size Cut Points](#)” on page 4-5.

## Cables

Optional cables include:

- Analog Data Cable
- 12/24 VDC Cable

### Analog Data Cable

The analog data, supporting both concentration output and alarm status, is typically used for analog data streaming to an external data logger and as a contact closure indicative of alarm conditions.

### 12/24 VDC Cable

This auxiliary cable permits the customer to power the instrument using a range of 12-24 VDC. However, the auxiliary power will not charge the internal battery.



## Pole Mounting Kits

Pole mounting kits include; 2-inch, 3-inch and 4-inch lengths. The pole mounting kits are designed to attach an enclosure to a vertical or horizontal pole (see “[Figure 2-1](#)”). For more information on pole mounting, see “[Positioning](#)” on page 2-5.

**Optional Accessories**

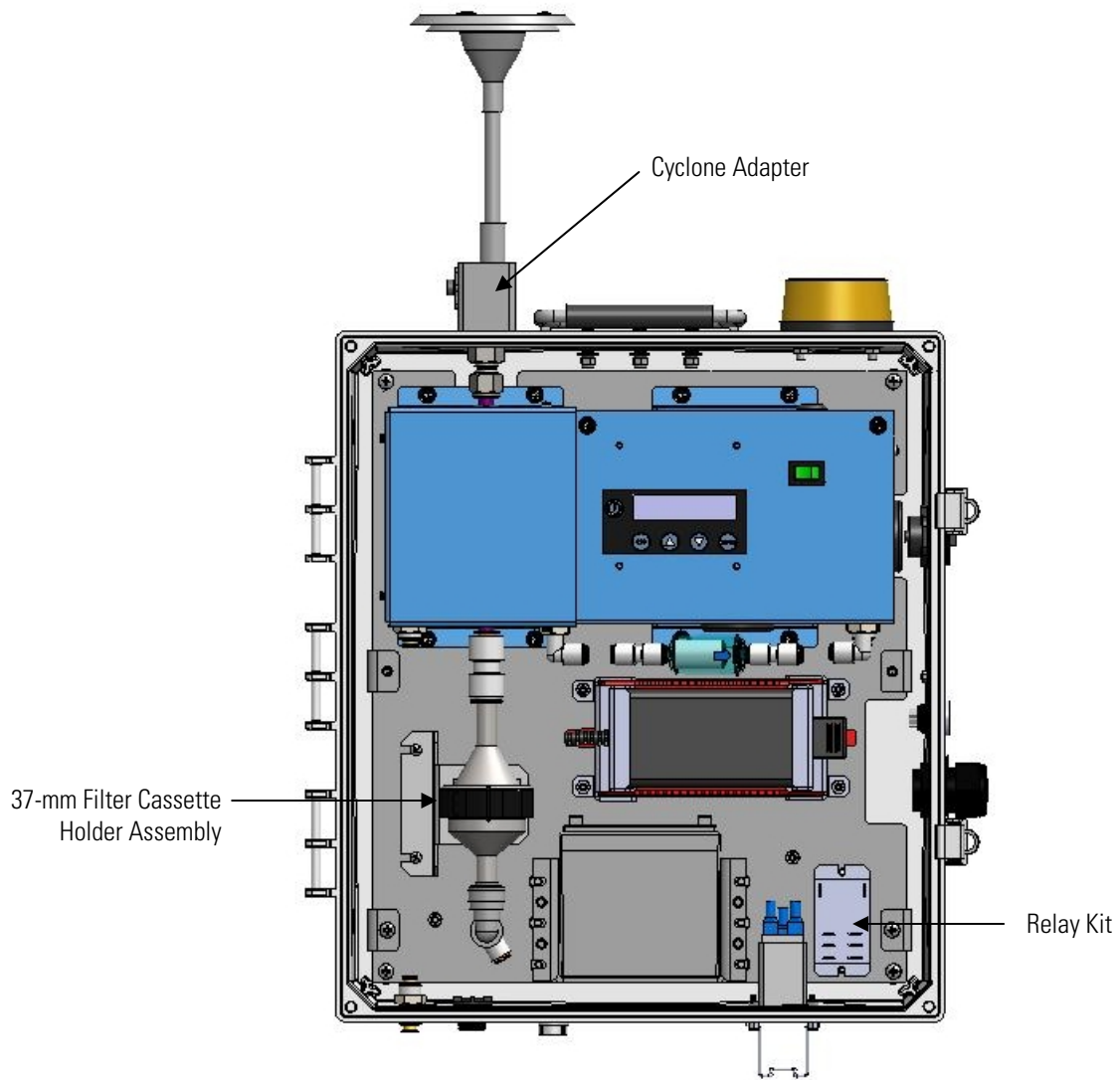

**Figure 8-2.** ADR-1500 Optional Accessories

# Appendix A

## Warranty

Seller warrants that the Products will operate or perform substantially in conformance with Seller's published specifications and be free from defects in material and workmanship, when subjected to normal, proper and intended usage by properly trained personnel, for the period of time set forth in the product documentation, published specifications or package inserts. If a period of time is not specified in Seller's product documentation, published specifications or package inserts, the warranty period shall be one (1) year from the date of shipment to Buyer for equipment and ninety (90) days for all other products (the "Warranty Period"). Seller agrees during the Warranty Period, to repair or replace, at Seller's option, defective Products so as to cause the same to operate in substantial conformance with said published specifications; provided that (a) Buyer shall promptly notify Seller in writing upon the discovery of any defect, which notice shall include the product model and serial number (if applicable) and details of the warranty claim; (b) after Seller's review, Seller will provide Buyer with service data and/or a Return Material Authorization ("RMA"), which may include biohazard decontamination procedures and other product-specific handling instructions; and (c) then, if applicable, Buyer may return the defective Products to Seller with all costs prepaid by Buyer. Replacement parts may be new or refurbished, at the election of Seller. All replaced parts shall become the property of Seller. Shipment to Buyer of repaired or replacement Products shall be made in accordance with the Delivery provisions of the Seller's Terms and Conditions of Sale. Consumables, including but not limited to lamps, fuses, batteries, bulbs and other such expendable items, are expressly excluded from the warranty under this warranty.

Notwithstanding the foregoing, Products supplied by Seller that are obtained by Seller from an original manufacturer or third party supplier are not warranted by Seller, but Seller agrees to assign to Buyer any warranty rights in such Product that Seller may have from the original manufacturer or third party supplier, to the extent such assignment is allowed by such original manufacturer or third party supplier.

In no event shall Seller have any obligation to make repairs, replacements or corrections required, in whole or in part, as the result of (i) normal wear and tear, (ii) accident, disaster or event of force majeure, (iii) misuse, fault or negligence of or by Buyer, (iv) use of the Products in a manner for which

## Warranty

they were not designed, (v) causes external to the Products such as, but not limited to, power failure or electrical power surges, (vi) improper storage and handling of the Products or (vii) use of the Products in combination with equipment or software not supplied by Seller. If Seller determines that Products for which Buyer has requested warranty services are not covered by the warranty hereunder, Buyer shall pay or reimburse Seller for all costs of investigating and responding to such request at Seller's then prevailing time and materials rates. If Seller provides repair services or replacement parts that are not covered by the warranty provided in this warranty, Buyer shall pay Seller therefor at Seller's then prevailing time and materials rates. ANY INSTALLATION, MAINTENANCE, REPAIR, SERVICE, RELOCATION OR ALTERATION TO OR OF, OR OTHER TAMPERING WITH, THE PRODUCTS PERFORMED BY ANY PERSON OR ENTITY OTHER THAN SELLER WITHOUT SELLER'S PRIOR WRITTEN APPROVAL, OR ANY USE OF REPLACEMENT PARTS NOT SUPPLIED BY SELLER, SHALL IMMEDIATELY VOID AND CANCEL ALL WARRANTIES WITH RESPECT TO THE AFFECTED PRODUCTS.

THE OBLIGATIONS CREATED BY THIS WARRANTY STATEMENT TO REPAIR OR REPLACE A DEFECTIVE PRODUCT SHALL BE THE SOLE REMEDY OF BUYER IN THE EVENT OF A DEFECTIVE PRODUCT. EXCEPT AS EXPRESSLY PROVIDED IN THIS WARRANTY STATEMENT, SELLER DISCLAIMS ALL OTHER WARRANTIES, WHETHER EXPRESS OR IMPLIED, ORAL OR WRITTEN, WITH RESPECT TO THE PRODUCTS, INCLUDING WITHOUT LIMITATION ALL IMPLIED WARRANTIES OF MERCHANTABILITY OR FITNESS FOR ANY PARTICULAR PURPOSE. SELLER DOES NOT WARRANT THAT THE PRODUCTS ARE ERROR-FREE OR WILL ACCOMPLISH ANY PARTICULAR RESULT.

# Appendix B

## Serial Commands

This appendix provides a list of the ADR-1500 Serial Port Commands that can be used to remotely control the instrument.

Connect to the ADR-1500 at 19200, n, 8, 1, no flow control. The USB connection is actually a virtual serial port and will request appropriate drivers the first time it fires up in a windows environment. These are available with the pDR Port install disk.

The protocol is designed for human terminal access. Commands are executed when the user hits Enter. Spaces between tokens do not matter. Generally, parameters not included in the command line are defaulted.

First is a list of key worded commands that should be made available to the end user as a public interface. With these commands you can completely control the instrument.

**ALARM** [*status*] [*alarm concentration level*]

*status* = {0, 1, 2,}

0 = DISABLED

1 = INSTANT

2 = STEL

*alarm concentration level* is specified in mg/m<sup>3</sup> (0.01 to 400 [mg/m<sup>3</sup>])

**ANALOGOUT** [*analog output menu choice*]

If the units are mass concentration (mg/m<sup>3</sup>), the *analog output menu choices*

= {0, 1, 2, 3, 4, 5, 6, 7, 8, 9}

0 = DISABLED

1 = 0.10 mg/m<sup>3</sup>

2 = 0.40 mg/m<sup>3</sup>

3 = 1.00 mg/m<sup>3</sup>

4 = 4.00 mg/m<sup>3</sup>

5 = 10.0 mg/m<sup>3</sup>

6 = 40 mg/m<sup>3</sup>

7 = 100 mg/m<sup>3</sup>

8 = 400 mg/m<sup>3</sup>

9 = 1000 mg/m<sup>3</sup>

If the units are scattering coefficient (1/Mm), the *analog output menu choices* = {0, 1, 2, 3, 4, 5}

0 = DISABLED

1 = 10/Mm

2 = 100/Mm

3 = 1000/Mm

4 = 10000/Mm

5 = 100000/Mm

The response is ANALOGOUT [menu] “menu entry” [factor to be applied to output voltage to yield output units (ie, mg/m<sup>3</sup> or 1/Mm)]

**AUTOSTART** [*min*] [*hour*] [*day*] [*month*] [*status*]

Returns, or programs, the automatic start feature parameters.

*min* and *hour* program the start time

*day* and *month* program the start day

*status* = {“on”, “off”} The automatic start is enabled if “on” is selected.

**BACKLIGHT** [*Status*]

Returns, or programs, the backlight status.

*Status* = {“enabled” or “on”, “disabled” or “off”}

**BATTERY** [*battery voltage*] [*alkaline charge*] [*NiMH charge*]

Returns the battery voltage with an estimation of charge time left in percentage if the batteries are Alkaline or NiMH.

**CALFACTOR** [*float value*]

Returns, or programs, the user calibration adjustment factor. The *value* can range from 0.001 to 10.000.

**CONTRAST** [*integer value*]

Returns, or programs, the LCD screen contrast setting.

*Integer value* = {1, 2, 3, ..., 255; *Hint: display is only visible between 0 and 40*}

**DATE** [*day*] [*month*] [*year*]

Returns, or programs, the date in the RTC.

*Day, month* and *year* are all integer values.

**DISPLAY** (or **DISP**, or **D**, or **V 5**) [*line 1 (16 characters)*] [*line 2 (16 characters)*] [*state #*]

Return the text currently displayed on the LCD. It comes in two quoted strings for the 2 lines of the display. It is followed by a state-number. Note that response is prefixed with “V 5”; this can be ignored.

**DISPLAYAVG** [*seconds*]

Returns, or programs, the time period in seconds over which the LCD displayed value is averaged.

**FLOWRATE** [*flow rate*]

Returns, or programs, the flow rate [LPM] that is to be maintained. This cannot be changed while logging.

*Flow rate* = {1.00, 1.01, 1.02, ..., 3.50} [in LPM]

**GAIN** [*gain number*]

A debug facility which returns or programs the front end gain of the instrument. If you set it, the gain no longer adjusts automatically. To re-establish auto-gain, use "GAIN 200" or "GAIN A"

*Gain number* = {0, 1, 2, 3, 4, 5, A} for {1X, 4X, 16X, 64X, 256X, 1024X and AUTOMATIC}

**INLET** [*integer*]

Returns, or programs, the inlet selection from the choices *integer* = {0, 1, 2}

0 = TOTAL

1 = CYCLONE RED

2 = CYCLONE BLUE

**KEY** [*name of key*] [*long*]

Simulate a key press.

*Name of key* = {"ESC", "UP", "DOWN", "ENTER" or "ONOFF"}

*Long* = {"LONG", ""} LONG is typed only if you wish this to be a long push.

**LOGPERIOD** [*seconds*]

Returns, or programs, the logging period in seconds.

**MEMORY** [*percent*]

Returns a reading of how much logging memory remains unused. The response is "V 145 [*percentage of memory remaining*]"

**OUTPUT** (or **OUT** or **O**) [*conc or scat*] [*temp (C)*] [*RH (%)*] [Pa (mmHg)]

Returns the current values of the concentrations, temperature, RH and atmospheric pressure if the pDR-1500 is running.

**RHCORRECT** [*status*]

Returns, or programs, the status of RH correction to the computation of mass concentration.

*Status* = {"disable" or "off", "enable" or "on"}

**SITE** [*site #*]

Returns, or programs, the description of site number sitenum. Sites are numbered 1–50.

**SD** [*Status*]

Returns, or programs, the streaming data status.

*Status* = {"enabled" or "on", "disabled" or "off"}

**TAG** [*Tag #*] [*status*]

Returns, or programs, the tag number to be used when next time logging is to start. And enable or disable logging.

*Tag #* = {00, 1, 2, ..., 99}

*Status* = {"enabled" or "on", "disabled" or "off"}

**TAGDUMP** [*Tag #*]

Returns the complete data logged under the file tag number.

*Tag #* = {0, 1, 2, ..., 99}

**TAGS** [*Tag #*], [*Tag #*], ...

Get a list of the tag files currently in the device.

**TEMP** [*temp*] [*RH*] [*Pa*]

Get current temperature, RH and atmospheric pressure.

*temp* is in degrees Celsius

*RH* is Relative Humidity in percent

*Pa* is barometric pressure in mmHG

**TEMPUNITS** [T]

Responds with "TEMPUNITS C", degrees Celsius are the only allowed.

**TIME** [*seconds*] [*minutes*] [*hours*]

Returns, or programs, the RTC's current time.

**UNITS** [*integer*] the current measurement units:

*Units* =

0 =  $\mu\text{g}/\text{m}^3$  (Mass concentration)

1 = 1/Mm (880 nm scattering coefficient)